

OPERATION MANUAL

HVS-TALOC20

HVS-TALOC32

Tally Open Collector Unit

HVS-TALR20

HVS-TALR32



Tally Relay Unit

2nd Edition



Precautions

Important Safety Warnings



[Power]

 Caution	Operate unit only on the specified supply voltage.
	Disconnect power cord by connector only. Do not pull on cable portion.
 Stop	Do not place or drop heavy or sharp-edged objects on power cord. A damaged cord can cause fire or electrical shock hazards. Regularly check power cord for excessive wear or damage to avoid possible fire / electrical hazards.

[Grounding]

 Caution	Ensure unit is properly grounded at all times to prevent electrical shock hazard.
 Hazard	Do not ground the unit to gas lines, units, or fixtures of an explosive or dangerous nature.
 Caution	Ensure power cord is firmly plugged into AC outlet.



[Operation]

 Hazard	Do not operate unit in hazardous or potentially explosive atmospheres. Doing so could result in fire, explosion, or other dangerous results.
 Hazard	Do not allow liquids, metal pieces, or other foreign materials to enter the unit. Doing so could result in fire, other hazards, or unit malfunction.
	If foreign material does enter the unit, turn power off and disconnect power cord immediately . Remove material and contact authorized service representative if damage has occurred.

[Transportation]

 Caution	Handle with care to avoid shocks in transit. Shocks may cause malfunction. When you need to transport the unit, use the original packing materials or alternate adequate packing.
--	--

[Circuitry Access]

 A black circle with a white border containing a white plug icon with a lightning bolt through it, indicating no power.	<p>Do not remove covers, panels, casing, or access circuitry with power applied to the unit! Turn power off and disconnect power cord prior to removal. Internal servicing / adjustment of unit should only be performed by qualified personnel.</p>
 A black circle with a white border containing a white hand with a lightning bolt through it, indicating no touch. Stop	<p>Do not touch any parts / circuitry with a high heat factor. Capacitors can retain enough electric charge to cause mild to serious shock, even after power is disconnected. Capacitors associated with the power supply are especially hazardous. Avoid contact with any capacitors.</p>
 A black triangle with a white border containing a white flame icon, indicating a hazard. Hazard	<p>Unit should not be operated or stored with cover, panels, and / or casing removed. Operating unit with circuitry exposed could result in electric shock / fire hazards or unit malfunction.</p>

[Potential Hazards]

 A black triangle with a white border containing a white lightning bolt icon, indicating caution. Caution	<p>If abnormal smells or noises are noticed coming from the unit, turn power off immediately and disconnect power cord to avoid potentially hazardous conditions. If problems similar to above occur, contact authorized service representative before attempting to again operate unit.</p>
--	---

[Consumables]

 A black triangle with a white border containing a white exclamation mark icon, indicating caution. Caution	<p>The consumables used in unit must be replaced periodically. For further details on which parts are consumables and when they should be replaced, refer to the specifications at the end of the Operation Manual. Since the service life of the consumables varies greatly depending on the environment in which they are used, they should be replaced at an early date. For details on replacing the consumables, contact your dealer.</p>
--	--

[Rubber Feet]

 A black circle with a white border containing a white exclamation mark icon, indicating caution. Caution	<p>If this product has come with rubber feet attached by screws, do not insert the screws again without rubber feet after removing the rubber feet and screws. It may cause damage to the internal circuits or components of the unit. To install the rubber feet again to the unit, do not use other than the supplied rubber feet and screws.</p>
--	---

Upon Receipt

Unpacking

Your Hanabi series tally unit and their accessories are fully inspected and adjusted prior to shipment. Operation can be performed immediately upon completing all required connections and operational settings.

Check your received items against the packing lists below.

If HVS-TALOC20/32

ITEM	QTY	REMARKS
HVS-TALOC20 or HVS-TALOC32	1	
Control cable	1	To MU RS-422 cable
Connector& Backshell	1 pr.	50-pin D-sub, male. For user cable connection fabrication (TALLY OUT connection)
Round connector	1	10-pin, male. For user cable connection fabrication (ALARM connection)
AC Cord	1	
Operation manual	1	

If HVS-TALR 20/32

ITEM	QTY	REMARKS
HVS-TALR20 or HVS-TALR32	1	
Control cable	1	To MU RS-422 cable
Connector& Backshell	2 pr.	50-pin D-sub, male. For user cable connection fabrication (TALLY OUT connection)
Round connector	1	10-pin, male. For user cable connection fabrication (ALARM connection)
AC Cord	1	
Operation manual	1	

Option

ITEM	QTY	REMARKS
Rack mount bracket set (type 1)	1 pr.	For single unit mount to a EIA 1RU rack space
Rack mount bracket set (type 2)	1 pr.	For mounting 2 units to a EIA 1RU rack space

Check

Check to ensure no damage has occurred during shipment. If damage has occurred, or items are missing, inform your supplier immediately.

Rack Mounting

The Hanabi series tally units can be either single unit or dual unit mounted to a 1RU space in EIA standard rack units. Racking mounting requires purchase of one of the two available rack mount kits.

When single unit mounting the single mount kit with one extended rack ear must be used. When dual unit mounting the dual mount kit with standard size rack ears must be used. Consult your FOR-A supplier to order either of these options.

Table of Contents

1. Prior to Starting	1
1-1. Welcome	1
1-2. About Hanabi Series Tally Units	1
1-3. About This Manual	1
2. Panel Descriptions	2
2-1. Front Panels	2
2-2. Rear Panels	2
3. Internal Settings	3
3-1. Accessing Internal Boards	3
3-2. TALLY Board (HVS-TALOC/HVS-TALR)	4
3-2-1. Unit ID	4
3-2-2. Other TALLY Board Switches	5
3-3. RELAY Board(HVS-TALR20/32)	6
3-3-1. RELAY Board Pin Settings	6
4. Connection	7
4-1. Connecting to the HVS-500/600HS	7
4-2. Connecting to the HVS-1000HS	8
4-3. Connecting to the HVS-1500/3800HS/S	9
5. Connector Information	10
5-1. CONTROL IN	10
5-2. CONTROL OUT	10
5-3. ALARM OUT	11
5-4. TALLY OUT(HVS-TALOC20)	12
5-4-1. TALLY OUT1	12
5-5. TALLY OUT(HVS-TALOC32)	13
5-5-1. TALLY OUT1	13
5-5-2. TALOC Circuit Diagram	14
5-6. TALLY OUT (HVS-TALR20)	15
5-6-1. TALLY OUT 1(HVS-TALR20)	15
5-6-2. TALLY OUT 2(HVS-TALR20)	16
5-7. TALLY OUT (HVS-TALR32)	17
5-7-1. TALLY OUT 1(HVS-TALR32)	17
5-7-2. TALLY OUT 2(HVS-TALR32)	18
5-7-3. TALR Circuit Diagrams	19
5-8. DC 24V OUT	20
6. Specifications & Dimensions	21
6-1. TALOC Specifications	21
6-1-1. HVS-TALOC20/ HVS-TALOC32	21
6-1-2. HVS-TALR20/ HVS-TALR32	21
6-2. External Dimensions	22
6-2-1. HVS-TALOC20/32	22
6-2-2. HVS-TALR20/32	23

1. Prior to Starting

1-1. Welcome

Congratulations! By purchasing the Hanabi series tally unit you have entered the world of FOR.A and its many innovative products. Thank you for your patronage and we hope you will turn to FOR.A products again and again to satisfy your video and audio production needs.

FOR.A provides a wide range of products, from basic support units to complex system controllers, which have been increasingly joined by products for computer video based systems. Whatever your needs, talk to your FOR.A representative. We will do our best to be of continuing service to you.

1-2. About Hanabi Series Tally Units

When configured within a Hanabi system, the Hanabi series tally unit adds signal tally display indication support to your switcher system.

Features

- Converts serial tally outputs from Hanabi series switchers into parallel open collector outputs (HVS-TALOC). 20/32 output options.
- Converts serial tally outputs from Hanabi series switchers into tally relay outputs, normally open/close, for each (HVS-TALR). 20/32 output options.
- Expand TALLY signal indication support by configuring up to any 5 Hanabi series tally units.
- Compact EIA 1RU half width. Rack mountable with an optional rack mount bracket set.

1-3. About This Manual

This manual is intended to help the user easily operate the Hanabi series tally unit and to make full use of all functions during operations. Before connecting or operating the Hanabi series tally unit, read this operation manual thoroughly to ensure you completely understand the product. After reading, it is important to keep this manual in a safe place and available for later reference.

2. Panel Descriptions

This chapter explains connections located on the front panel and rear panel of the HVS-TALOC20. Those of the other units are almost the same as this model

2-1. Front Panels

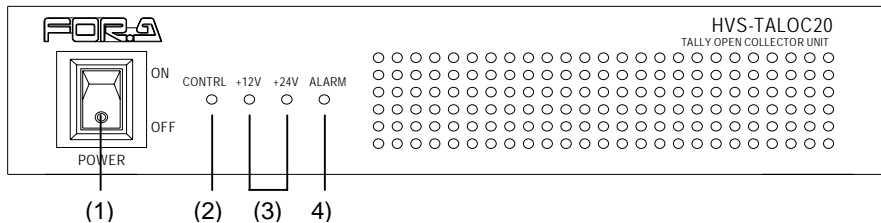

(1)	POWER	Switch used to turn unit power ON / OFF.
(2)	CONTROL	Indicator lights green whenever the unit communicates with the Hanabi switcher. Indicator turns off when the connection with the switcher is not properly made or a malfunction occurs.
(3)	+12V +24V	Both +12V and +24V voltage indicators lights green when power switch is set to ON and all related voltages are present. If one or more of the voltage indicators are unlit, related power supply voltage has failed and is not present.
(4)	ALARM	Indicator remains unlit if fan is operating normally. Indicator goes to red indication if failure has occurred.

2-2. Rear Panels

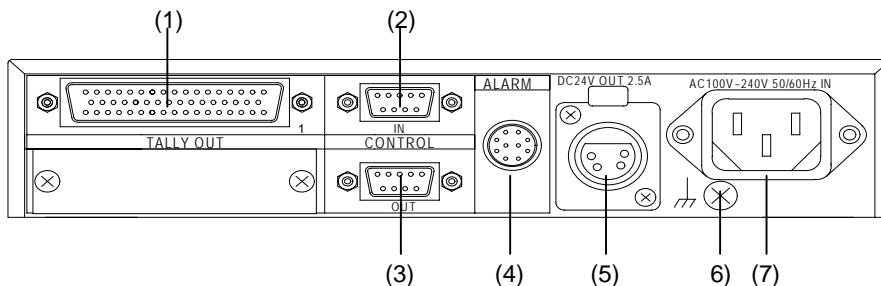

(1)	TALLY OUT	Used for tally signal outputs from the Hanabi switcher to other tally units. 50-pin D-sub connector (female), 1 ea. (HVS-TALOC20/32), 2 ea. (HVS-TALR20/32).
(2)	CONTROL IN	Used for control connection from configured Hanabi series switchers. RS-422 protocol. 9-pin D-sub connector (female).
(3)	CONTROL OUT	Used for cascade connection to other configured tally units. RS-422 protocol. 9-pin D-sub connector (female).
(4)	ALARM OUT	Used for alarm signal outputs to alarm / indication device. Also used for input of an external signal to reset tally operation.
(5)	Ground Terminal	Used to ground unit to protect operators against static electricity and / or electrical shock.
(6)	DC 24V OUT	Used for 24VDC power output.
(7)	AC IN	Used for connection to AC power source via supplied accessory cord.

3. Internal Settings

Depending on your system configuration, settings may have to be made at the dipswitches and jumpers on Hanabi series tally option internal boards. If changes are not required, board switch settings should be left at the factory made defaults given within this section.

3-1. Accessing Internal Boards

In order to make changes to settings on internal board(s), you will have to access the unit interior as explained following.

 <p>Caution</p>	<p>Unit interior should only be accessed by qualified technical personnel. Always switch unit power OFF and disconnect power cord before accessing unit interior to avoid possible electrical hazards.</p>
---	--

- 1) Remove the 8 screws securing the unit top panel. Screws are located at the points indicated by the arrows in the figure below. Place screws in a safe place to reuse later.

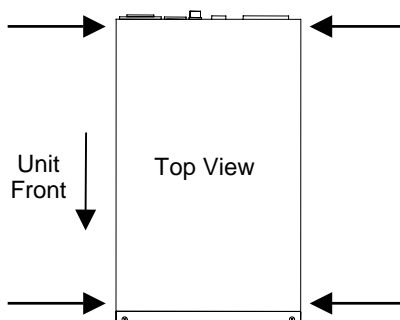

- 2) Completely remove top panel. After panel is removed, the internal board(s) should be located inside the unit at the position(s) indicated in the figure below.

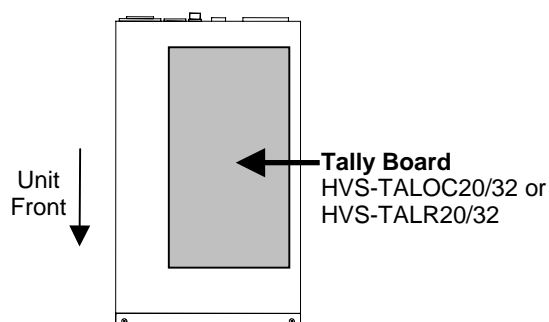

- 3) Refer to section 3-2 "TALLY Board (HVS-TALOC/HVS-TALR)" to make settings on the internal TALLY board (A) on both HVS-TALOC20/32 and HVS-TALR20/32. Refer to section 3-3 "RELAY Board(HVS-TALR20/32)" to make settings on internal RELAY board (B) of the HVS-TALR20/32.
- 4) After all required settings are made, replace unit top panel and re-secure it in place with the screws removed in step 1).

3-2. TALLY Board (HVS-TALOC/HVS-TALR)

The TALLY board is common to both the HVS-TALOC and HVS-TALR and is primarily used to set unit ID. Refer to section 3-1 "Accessing Internal Boards" for accessing the TALLY boards.

3-2-1. Unit ID

The operational ID for your tally unit is set at SW36 on the internal TALLY board.

When tally units are cascade connected, a different ID number must be set at each unit configured. Tally unit ID numbers can be set from 1 and 5, with 1 being the factory default ID. (ID 0 is not available.)

If you are configuring only one unit, leave it to factory default ID 1.

If you are configuring more than one unit, ID set at the internal TALLY board of each unit must be set to a different ID number for tally operation to occur correctly. (No repeat numbers.)

■ Tally Board

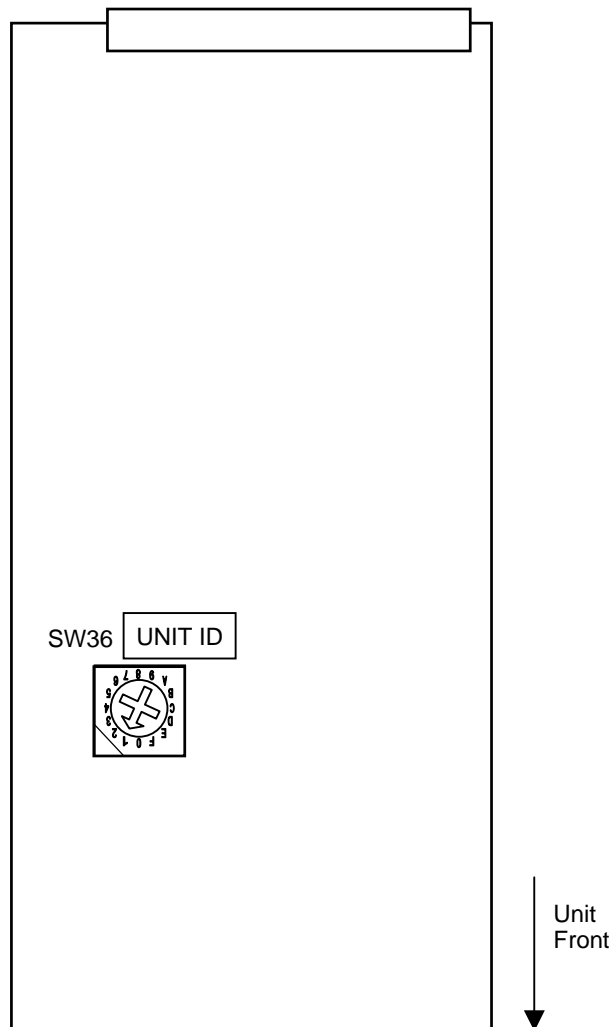

3-2-2. Other TALLY Board Switches

IMPORTANT

Settings for all other switches except SW36 on TALLY board should be left to the factory settings shown below. **Do not change. Factory settings are given for reference only. Simply verify settings on TALLY board are as shown.**

■ Tally Board (A)

Slide switch SW34

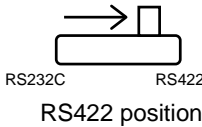

Slide switch SW35

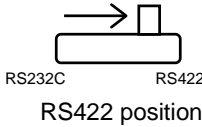

Dipswitch SW33

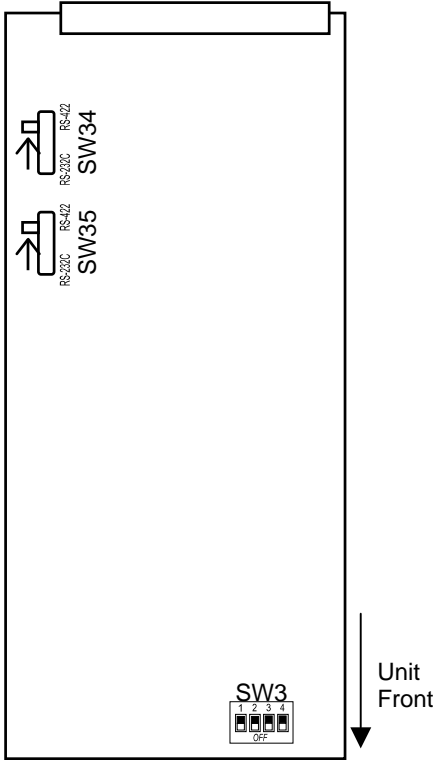
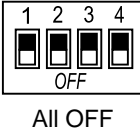

3-3. RELAY Board(HVS-TALR20/32)

The RELAY board will only be present if you have purchased the HVS-TALR unit. It will not be present on HVS-TALOC units. After accessing unit interior (see section 3-1 “Accessing Internal Boards” for details) remove all ribbon cables connected to the relay board to access the switches. Pay careful attention to the original position of each cable when removing. Ribbon cables must be connected back to their original positions after dipswitch settings are made.

3-3-1. RELAY Board Pin Settings

In the case of the HVS-TALR20/32, pin output can be set as either contact initiated (DRY CONTACT) or 24VDC (V OUT).

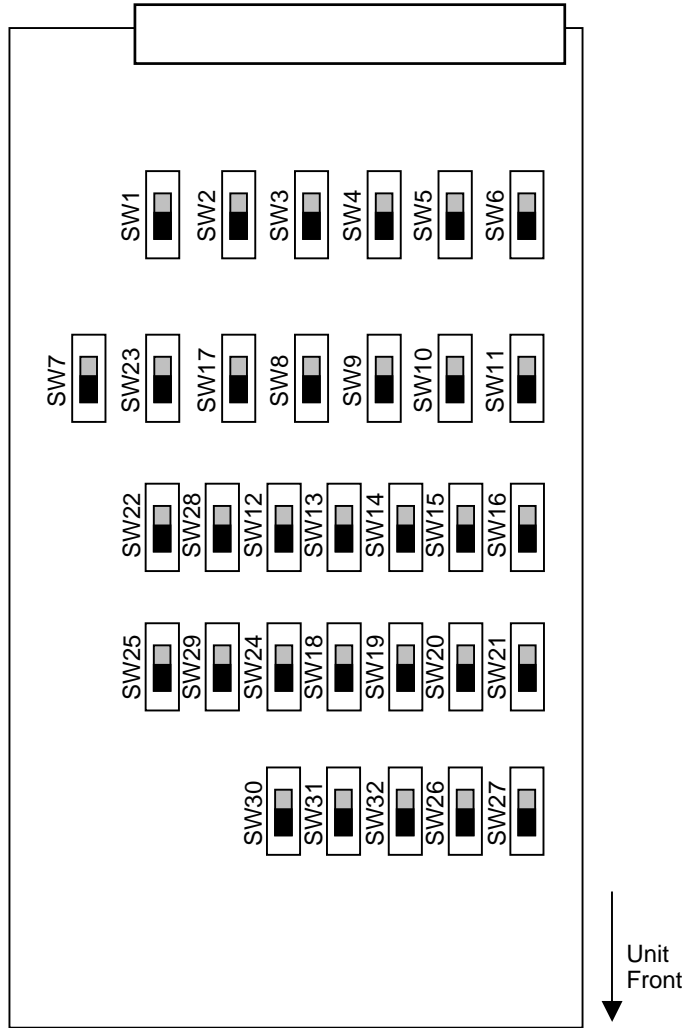
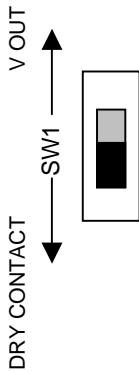

* Factory default settings shown above. Factory default = Contact initiated (DRY CONTACT)

■ Switch Signal Reference Table

Dipswitch	TALLY Output Pin	TALLY Output Connector
S1 – S16	Tally Out 1-16	TALLY OUT1
S17 – S32	Tally Out 17-32	TALLY OUT2

Use above switches S1 – S32 to change correspondingly numbered output connector pins between contact initiated (DRY CONTACT) or 24VDC (V OUT). See section 5-6 “TALLY OUT (HVS-TALR20)” and 5-7 “TALLY OUT (HVS-TALR32)” for related output response information.

4. Connection

Hanabi series tally unit connections should generally be made as shown below. Up to a max. of any 5 Hanabi series tally units (assigned different ID numbers) can be cascade connected.

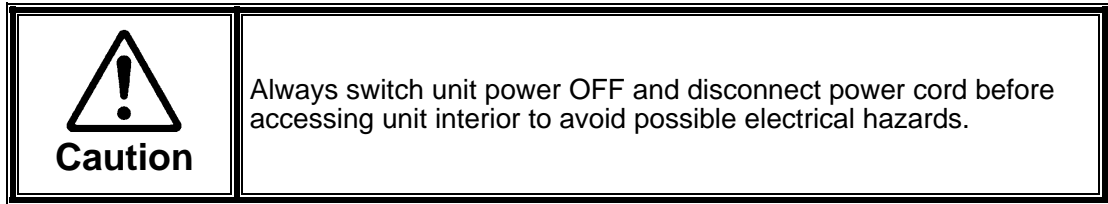

4-1. Connecting to the HVS-500/600HS

Use the supplied control cable (RS-422, straight-through) to connect the HVS-500/600HS RS-422 connector and the CONTROL IN connector of the first Hanabi tally unit. Then use the supplied control cable (RS-422, straight-through) to connect the first tally unit CONTROL OUT connector and the CONTROL IN connector of the second tally unit.

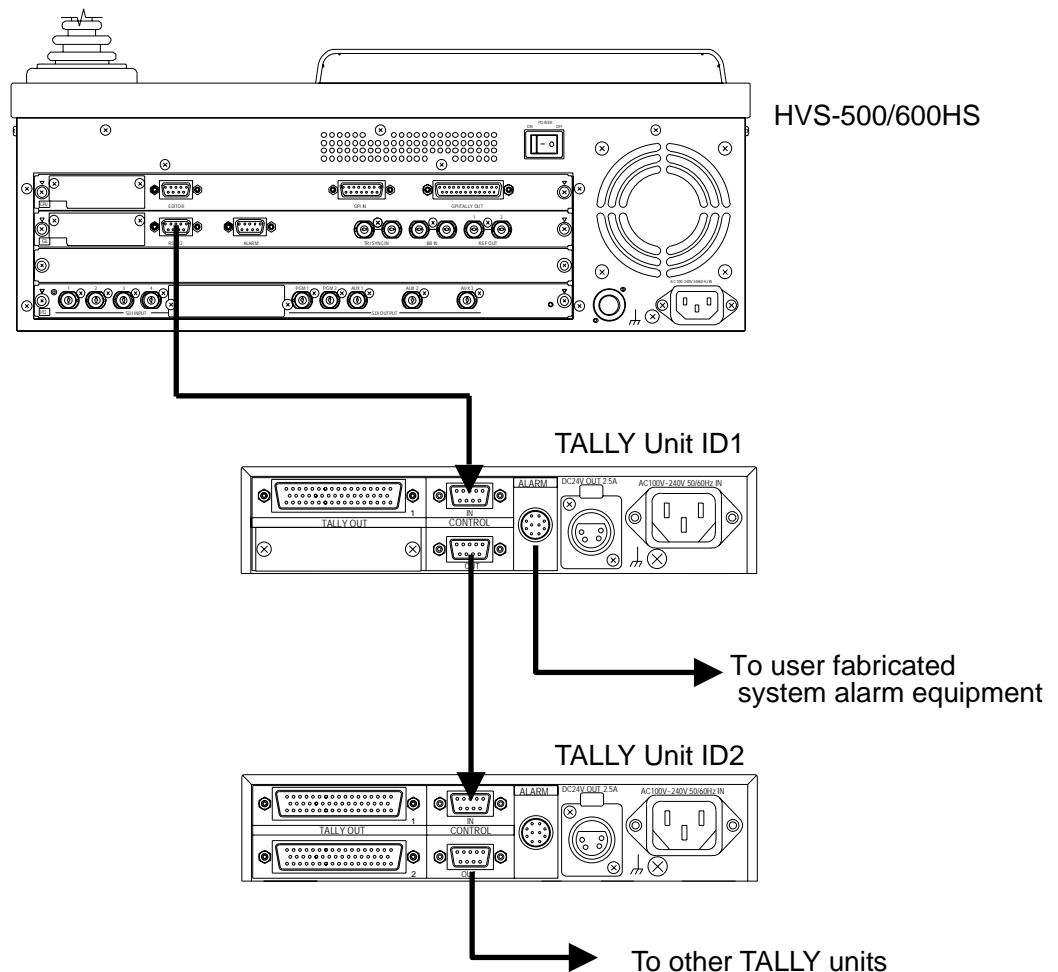

4-2. Connecting to the HVS-1000HS

Use the supplied control cable (RS-422, straight-through) to connect the HVS-1000HS RS-422 connector and the CONTROL IN connector of the first Hanabi tally unit. Then use the supplied control cable (RS-422, straight-through) to connect the first tally unit CONTROL OUT connector and the CONTROL IN connector of the second tally unit.

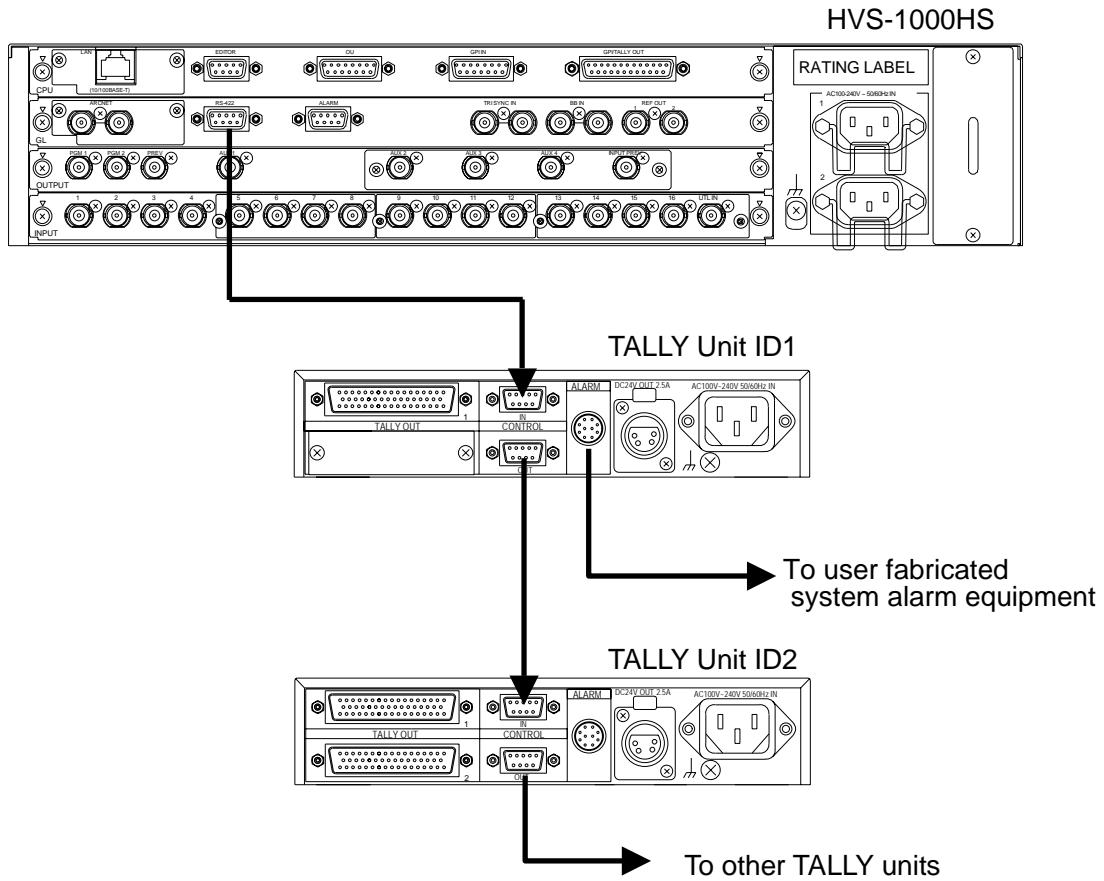

4-3. Connecting to the HVS-1500/3800HS/S

Use the supplied control cable (RS-422, straight-through) to connect the HVS-1500/3800HS/S RS-422 (3) connector and the CONTROL IN connector of the first Hanabi tally unit. Then use the supplied control cable (RS-422, straight-through) to connect the first tally unit CONTROL OUT connector and the CONTROL IN connector of the second tally unit.

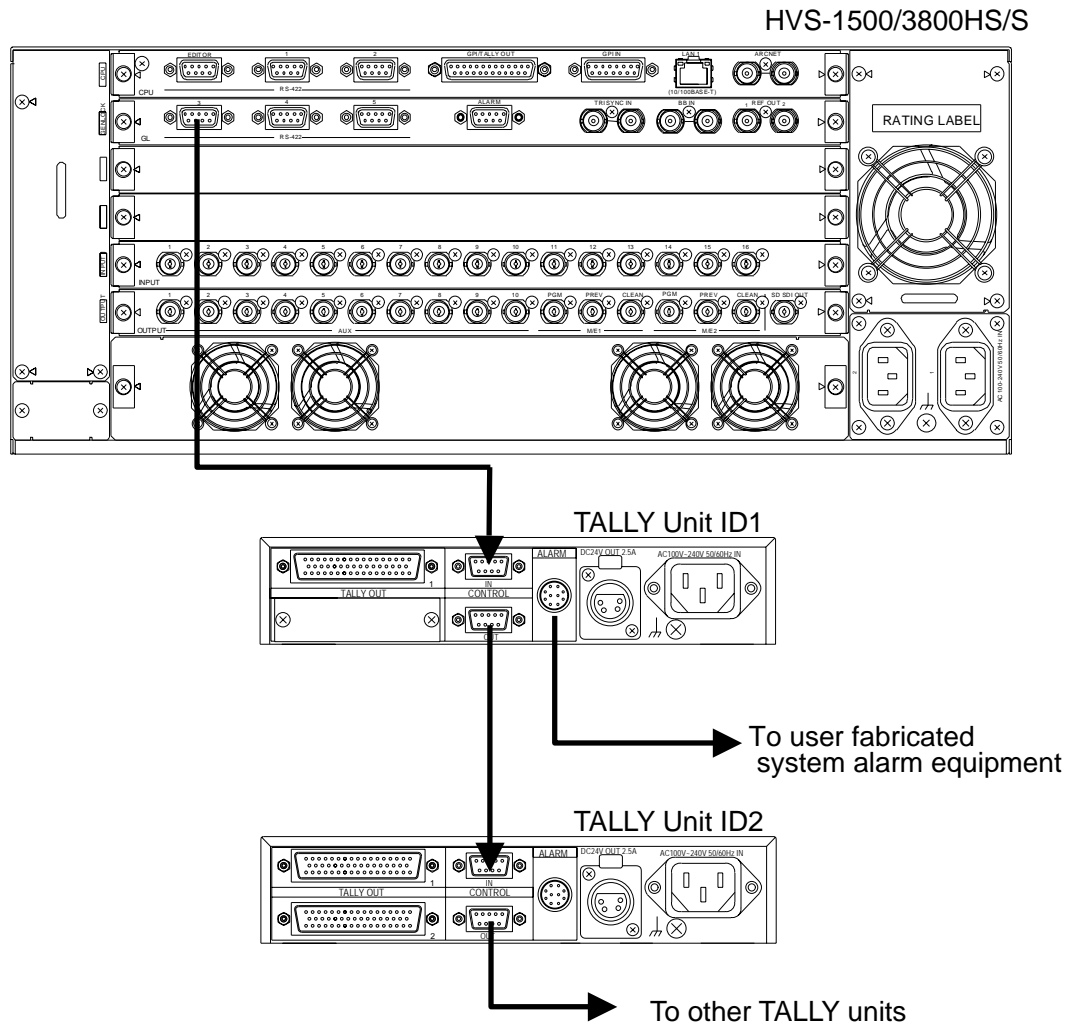

5. Connector Information

5-1. CONTROL IN

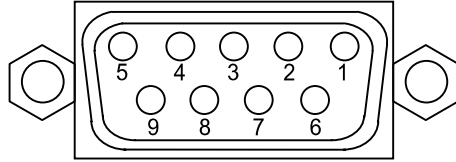

■ CONTROL IN Connector Pin Assignment Table (RS422 9-pin D-sub, female)

PIN No.	Signal	Description
1	FG	Frame ground
2	T (-)	Transmit data (-)
3	R (+)	Receive data (+)
4	SG	Signal ground
5	SG	Signal ground
6	SG	Signal ground
7	T (+)	Transmit data (+)
8	R (-)	Receive data (-)
9	FG	Frame ground

■ Cabling

Use accessory control cable supplied with your Hanabi TALLY unit.

5-2. CONTROL OUT

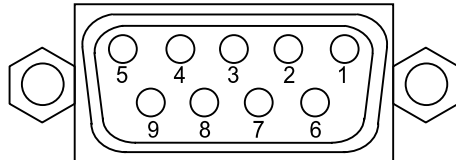

■ CONTROL OUT Connector Pin Assignment Table (RS422 9-pin D-sub, female)

PIN No.	Signal	Description
1	FG	Frame ground
2	R (-)	Receive data (-)
3	T (+)	Transmit data (+)
4	SG	Signal ground
5	SG	Signal ground
6	SG	Signal ground
7	R (+)	Receive data (+)
8	T (-)	Transmit data (-)
9	FG	Frame ground

■ Cabling

Use accessory control cable supplied with other Hanabi TALLY unit.

5-3. ALARM OUT

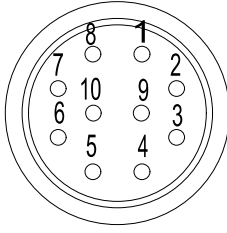

■ **ALARM OUT Connector Pin Assignment Table (10-pin round connector, female)**

Pin No.	Signal	Description
1	FAN ALARM OUT	Fan failure alarm. Normally open relay.
2	POWER ALARM OUT	Power failure alarm. Normally open relay.
3	-	Open
4	-	Open
5	RESET IN	External reset input. Active low initiate.
6	FAN ALARM COMMON	Fan alarm signal common.
7	POWER ALARM COMMON	Power alarm signal common.
8	-	Open
9	SG	Signal ground
10	-	Open

■ **ALARM OUT Circuit**

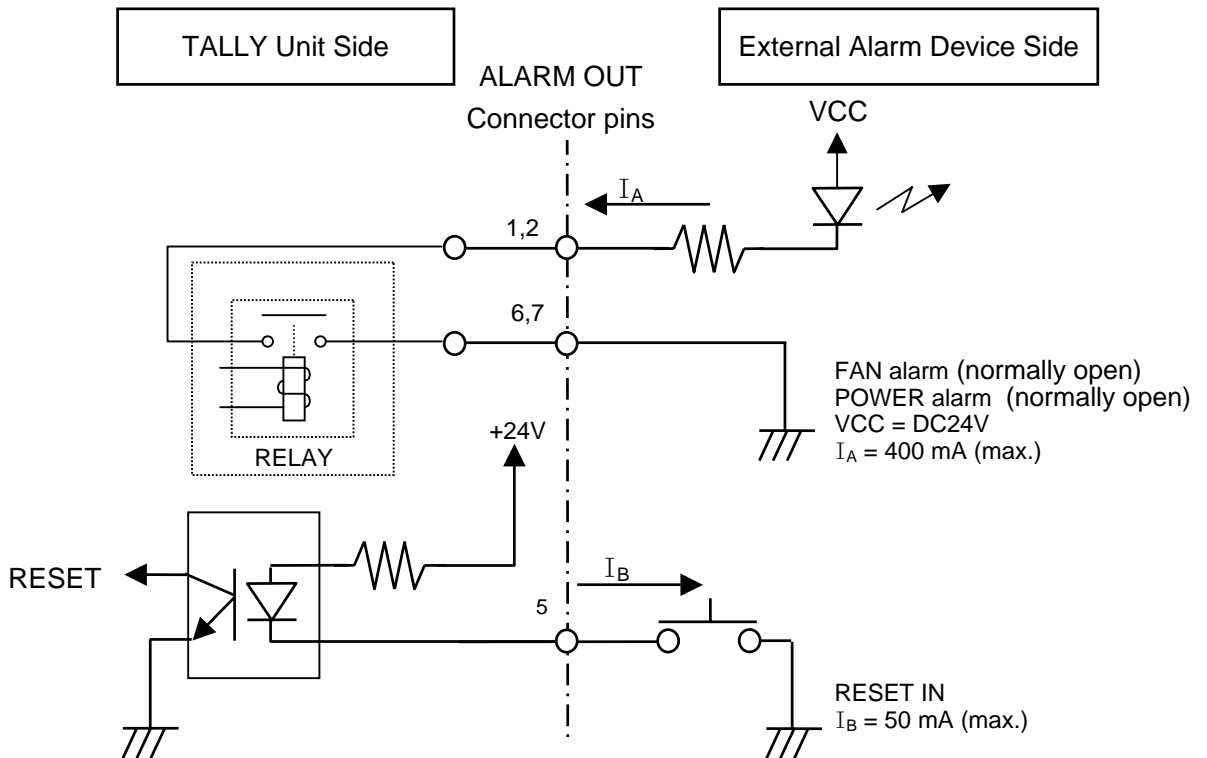

5-4. TALLY OUT(HVS-TALOC20)

5-4-1. TALLY OUT1

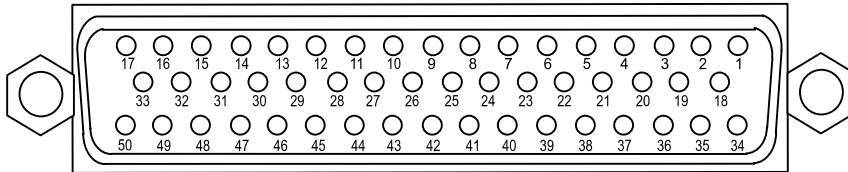

■ TALLY OUT1 Connector Pin Assignment Table (50-pin D-sub, female)

Pin No.	Signal	Pin No.	Signal
1	Tally OUT1	26	OPEN
2	Tally OUT2	27	OPEN
3	Tally OUT3	28	OPEN
4	Tally OUT4	29	OPEN
5	Tally OUT5	30	OPEN
6	Tally OUT6	31	OPEN
7	Tally OUT7	32	OPEN
8	Tally OUT8	33	OPEN
9	Tally OUT9	34	GND
10	Tally OUT10	35	GND
11	Tally OUT11	36	GND
12	Tally OUT12	37	GND
13	Tally OUT13	38	GND
14	Tally OUT14	39	GND
15	Tally OUT15	40	GND
16	Tally OUT16	41	GND
17	Tally OUT17	42	GND
18	Tally OUT18	43	GND
19	Tally OUT19	44	GND
20	Tally OUT20	45	GND
21	OPEN	46	GND
22	OPEN	47	GND
23	OPEN	48	GND
24	OPEN	49	GND
25	OPEN	50	GND

■ To fabricate connection cable:

Use accessory 50-pin D-sub (male) connector assembly supplied with your HVS-TALOC20. Assembly parts supplied are as given below.

Backshell: DD-C8-J13 (JAE)

Connector Core: D50P-N (JAE)

NOTE

The table above is pin assignments for the HVS-TALOC20 (open collector units).

5-5. TALLY OUT(HVS-TALOC32)

5-5-1. TALLY OUT1

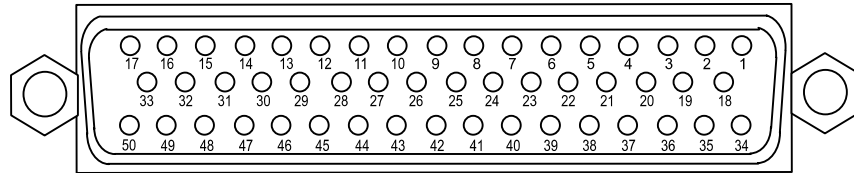

■ TALLY OUT 1 Connector Pin Assignment Table (50-pin D-sub, female)

Pin No.	Signal	Pin No.	Signal
1	Tally OUT1	26	Tally OUT26
2	Tally OUT2	27	Tally OUT27
3	Tally OUT3	28	Tally OUT28
4	Tally OUT4	29	Tally OUT29
5	Tally OUT5	30	Tally OUT30
6	Tally OUT6	31	Tally OUT31
7	Tally OUT7	32	Tally OUT32
8	Tally OUT8	33	OPEN
9	Tally OUT9	34	GND
10	Tally OUT10	35	GND
11	Tally OUT11	36	GND
12	Tally OUT12	37	GND
13	Tally OUT13	38	GND
14	Tally OUT14	39	GND
15	Tally OUT15	40	GND
16	Tally OUT16	41	GND
17	Tally OUT17	42	GND
18	Tally OUT18	43	GND
19	Tally OUT19	44	GND
20	Tally OUT20	45	GND
21	Tally OUT21	46	GND
22	Tally OUT22	47	GND
23	Tally OUT23	48	GND
24	Tally OUT24	49	GND
25	Tally OUT25	50	GND

■ To fabricate connection cable:

Use accessory 50-pin D-sub (male) connector assembly supplied with your HVS-TALOC32. Assembly parts supplied are as given below.

Backshell: DD-C8-J13 (JAE)

Connector Core: D50P-N (JAE)

NOTE

The table above is pin assignments for the HVS-TALOC32 (open collector units).

5-5-2. TALOC Circuit Diagram

■ HVS-TALOC20/ HVS-TALOC32 (Equivalent circuit)

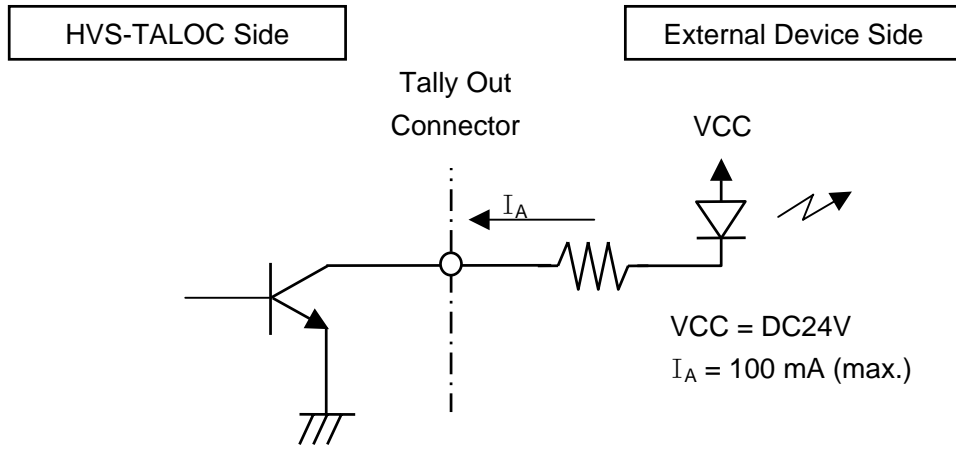

5-6. TALLY OUT (HVS-TALR20)

5-6-1. TALLY OUT 1(HVS-TALR20)

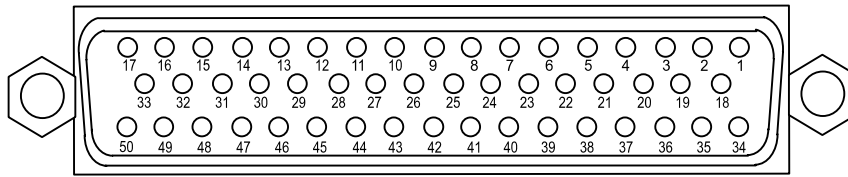

◆ **TALLY OUT 1 Connector Pin Assignment Table (50-pin D-sub, female)**

Pin No.	Signal	#	Pin No.	Signal	#
1	Tally OUT1 (C.) *1	1	28	Tally OUT 10 (C.)	10
2	Tally OUT1 (COM.) *2		29	Tally OUT 10 (COM.)	
3	Tally OUT1 (O.) *3		30	Tally OUT 10 (O.)	
4	Tally OUT2 (C.)	2	31	Tally OUT 11 (C.)	11
5	Tally OUT2 (COM.)		32	Tally OUT 11 (COM.)	
6	Tally OUT2 (O.)		33	Tally OUT 11 (O.)	
7	Tally OUT3 (C.)	3	34	Tally OUT 12 (C.)	12
8	Tally OUT3 (COM.)		35	Tally OUT 12 (COM.)	
9	Tally OUT3 (O.)		36	Tally OUT 12 (O.)	
10	Tally OUT4 (C.)	4	37	Tally OUT 13 (C.)	13
11	Tally OUT4 (COM.)		38	Tally OUT 13 (COM.)	
12	Tally OUT4 (O.)		39	Tally OUT 13 (O.)	
13	Tally OUT5 (C.)	5	40	Tally OUT 14 (C.)	14
14	Tally OUT5 (COM.)		41	Tally OUT 14 (COM.)	
15	Tally OUT5 (O.)		42	Tally OUT 14 (O.)	
16	Tally OUT6 (C.)	6	43	Tally OUT 15 (C.)	15
17	Tally OUT6 (COM.)		44	Tally OUT 15 (COM.)	
18	Tally OUT6 (O.)		45	Tally OUT 15 (O.)	
19	Tally OUT7 (C.)	7	46	Tally OUT 16 (C.)	16
20	Tally OUT7 (COM.)		47	Tally OUT 16 (COM.)	
21	Tally OUT7 (O.)		48	Tally OUT 16 (O.)	
22	Tally OUT8 (C.)	8	49	OPEN	
23	Tally OUT8 (COM.)		50	GND	
24	Tally OUT8 (O.)				
25	Tally OUT9 (C.)	9			
26	Tally OUT9 (COM.)				
27	Tally OUT9 (O.)				

Output number

*1) C. = Closed circuit, *2) COM. = Common, *3) O. = Open circuit

◆ **To fabricate connection cable:**

Use accessory 50-pin D-sub (male) connector assembly supplied with your HVS-TALR20. Assembly parts supplied are as given below.

Backshell: DD-C8-J13 (JAE))

Connector Core: D50P-N (JAE)

NOTE

The table above is pin assignments for the HVS-TALR20 (relay units).

5-6-2. TALLY OUT 2(HVS-TALR20)

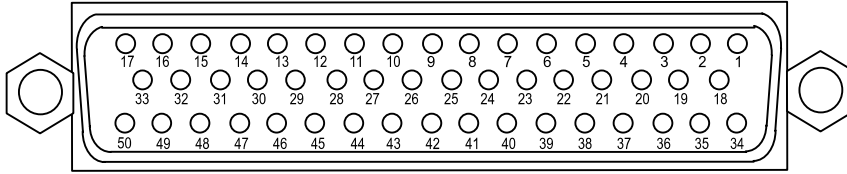

◆ TALLY OUT 2 Connector Pin Assignment Table (50-pin D-sub, female)

Pin No.	Signal	#	Pin No.	Signal	#
1	Tally OUT17 (C.) *1	17	28	OPEN	
2	Tally OUT17 (COM.) *2		29	OPEN	
3	Tally OUT17 (O.) *3		30	OPEN	
4	Tally OUT18 (C.)	18	31	OPEN	
5	Tally OUT18 (COM.)		32	OPEN	
6	Tally OUT18 (O.)		33	OPEN	
7	Tally OUT19 (C.)	19	34	OPEN	
8	Tally OUT19 (COM.)		35	OPEN	
9	Tally OUT19 (O.)		36	OPEN	
10	Tally OUT20 (C.)	20	37	OPEN	
11	Tally OUT20 (COM.)		38	OPEN	
12	Tally OUT20 (O.)		39	OPEN	
13	OPEN		40	OPEN	
14	OPEN		41	OPEN	
15	OPEN		42	OPEN	
16	OPEN		43	OPEN	
17	OPEN		44	OPEN	
18	OPEN		45	OPEN	
19	OPEN		46	OPEN	
20	OPEN		47	OPEN	
21	OPEN		48	OPEN	
22	OPEN		49	OPEN	
23	OPEN	50	GND		
24	OPEN				
25	OPEN				
26	OPEN				
27	OPEN				

Output number

*1) C. = Closed circuit, *2) COM. = Common, *3) O. = Open circuit

◆ To fabricate connection cable:

Use accessory 50-pin D-sub (male) connector assembly supplied with your HVS-TALR20.

Assembly parts supplied are as given below.

Backshell: DD-C8-J13 (JAE)

Connector Core: D50P-N (JAE)

NOTE

The table above is pin assignments for the HVS-TALR20 (relay units).

5-7. TALLY OUT (HVS-TALR32)

5-7-1. TALLY OUT 1(HVS-TALR32)

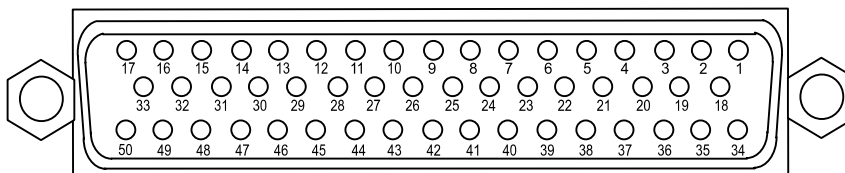

◆ **TALLY OUT 1 Connector Pin Assignment Table (50-pin D-sub, female)**

Pin No.	Signal	#	Pin No.	Signal	#
1	Tally OUT1 (C.) *1)	1	28	Tally OUT 10 (C.)	10
2	Tally OUT1 (COM.) *2)		29	Tally OUT 10 (COM.)	
3	Tally OUT1 (O.) *3)		30	Tally OUT 10 (O.)	
4	Tally OUT2 (C.)	2	31	Tally OUT 11 (C.)	11
5	Tally OUT2 (COM.)		32	Tally OUT 11 (COM.)	
6	Tally OUT2 (O.)		33	Tally OUT 11 (O.)	
7	Tally OUT3 (C.)	3	34	Tally OUT 12 (C.)	12
8	Tally OUT3 (COM.)		35	Tally OUT 12 (COM.)	
9	Tally OUT3 (O.)		36	Tally OUT 12 (O.)	
10	Tally OUT4 (C.)	4	37	Tally OUT 13 (C.)	13
11	Tally OUT4 (COM.)		38	Tally OUT 13 (COM.)	
12	Tally OUT4 (O.)		39	Tally OUT 13 (O.)	
13	Tally OUT5 (C.)	5	40	Tally OUT 14 (C.)	14
14	Tally OUT5 (COM.)		41	Tally OUT 14 (COM.)	
15	Tally OUT5 (O.)		42	Tally OUT 14 (O.)	
16	Tally OUT6 (C.)	6	43	Tally OUT 15 (C.)	15
17	Tally OUT6 (COM.)		44	Tally OUT 15 (COM.)	
18	Tally OUT6 (O.)		45	Tally OUT 15 (O.)	
19	Tally OUT7 (C.)	7	46	Tally OUT 16 (C.)	16
20	Tally OUT7 (COM.)		47	Tally OUT 16 (COM.)	
21	Tally OUT7 (O.)		48	Tally OUT 16 (O.)	
22	Tally OUT8 (C.)	8	49	OPEN	
23	Tally OUT8 (COM.)		50	GND	
24	Tally OUT8 (O.)				
25	Tally OUT9 (C.)	9			
26	Tally OUT9 (COM.)				
27	Tally OUT9 (O.)				

Output number

*1) C. = Closed circuit, *2) COM. = Common, *3) O. = Open circuit

◆ **To fabricate connection cable:**

Use accessory 50-pin D-sub (male) connector assembly supplied with your HVS-TALR32. Assembly parts supplied are as given below.

Backshell: DD-C8-J13 (JAE))

Connector Core: D50P-N (JAE)

NOTE

The table above is pin assignments for the HVS-TALR32 (relay units).

5-7-2. TALLY OUT 2(HVS-TALR32)

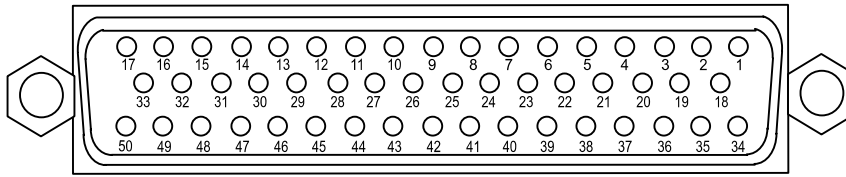

◆ TALLY OUT 2 Connector Pin Assignment Table (50-pin D-sub, female)

Pin No.	Signal	#	Pin No.	Signal	#
1	Tally OUT17 (C.) *1)	17	28	Tally OUT26 (C.)	26
2	Tally OUT17 (COM.) *2)		29	Tally OUT26 (COM.)	
3	Tally OUT17 (O.) *3)		30	Tally OUT26 (O.)	
4	Tally OUT18 (C.)	18	31	Tally OUT27 (C.)	27
5	Tally OUT18 (COM.)		32	Tally OUT27 (COM.)	
6	Tally OUT18 (O.)		33	Tally OUT27 (O.)	
7	Tally OUT19 (C.)	19	34	Tally OUT28 (C.)	28
8	Tally OUT19 (COM.)		35	Tally OUT28 (COM.)	
9	Tally OUT19 (O.)		36	Tally OUT28 (O.)	
10	Tally OUT20 (C.)	20	37	Tally OUT29 (C.)	29
11	Tally OUT20 (COM.)		38	Tally OUT29 (COM.)	
12	Tally OUT20 (O.)		39	Tally OUT29 (O.)	
13	Tally OUT21 (C.)	21	40	Tally OUT30 (C.)	30
14	Tally OUT21 (COM.)		41	Tally OUT30 (COM.)	
15	Tally OUT21 (O.)		42	Tally OUT30 (O.)	
16	Tally OUT22 (C.)	22	43	Tally OUT31 (C.)	31
17	Tally OUT22 (COM.)		44	Tally OUT31 (COM.)	
18	Tally OUT22 (O.)		45	Tally OUT31 (O.)	
19	Tally OUT23 (C.)	23	46	Tally OUT32 (C.)	32
20	Tally OUT23 (COM.)		47	Tally OUT32 (COM.)	
21	Tally OUT23 (O.)		48	Tally OUT32 (O.)	
22	Tally OUT24 (C.)	24	49	OPEN	
23	Tally OUT24 (COM.)		50	GND	
24	Tally OUT24 (O.)				
25	Tally OUT25 (C.)	25			
26	Tally OUT25 (COM.)				
27	Tally OUT25 (O.)				

Output number

*1) C. = Closed circuit, *2) COM. = Common, *3) O. = Open circuit

◆ To fabricate connection cable:

Use accessory 50-pin D-sub (male) connector assembly supplied with your HVS-TALR32. Assembly parts supplied are as given below.

Backshell: DD-C8-J13 (JAE)

Connector Core: D50P-N (JAE)

NOTE

The table above is pin assignments for the HVS-TALR32 (relay units).

5-7-3. TALR Circuit Diagrams

■ TALLY OUT 1 – 2 Voltage Output Circuit (HVS-TALR20/32)

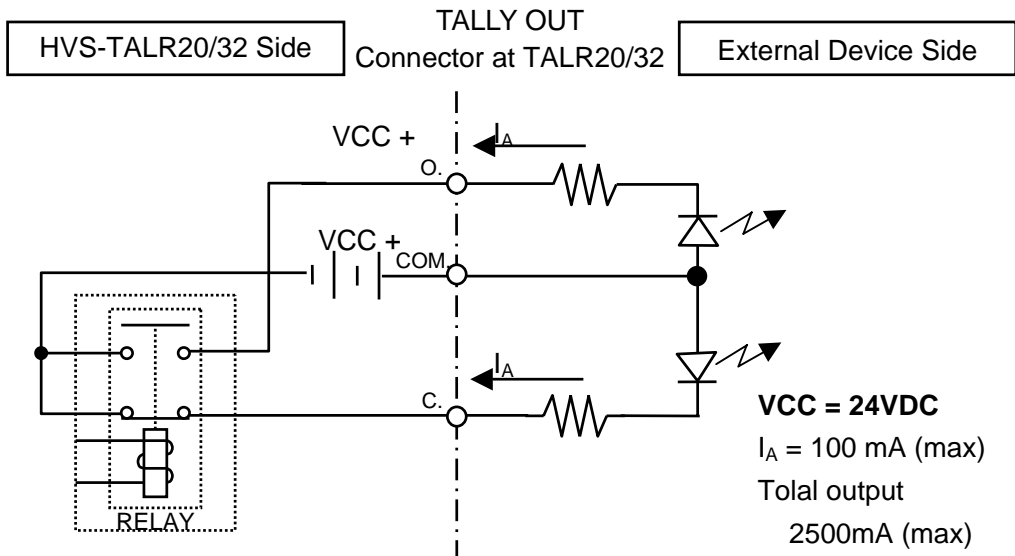

■ TALLY OUT 1 – 2 Contact Initiated Circuit (HVS-TALR20/32)

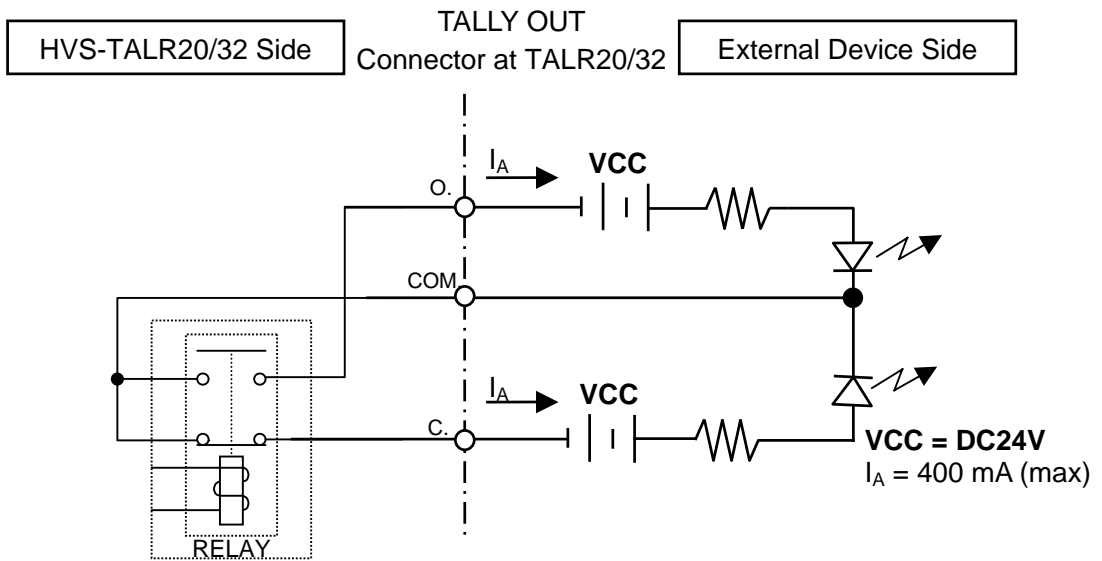

Caution

When voltage output is set, the max. load at that pin is 100mA. If more than 100mA is required, set pin to contact initiate mode.

The maximum current supplied to the DC OUT connector is 2.5A. Do not feed a current exceeding 2.5A.

If the fuse protection starts accidentally, disconnect the DC power cable from the unit, power off the unit and set it aside more than 5 minutes until it cools.

5-8. DC 24V OUT

DC24V OUT 2.5A

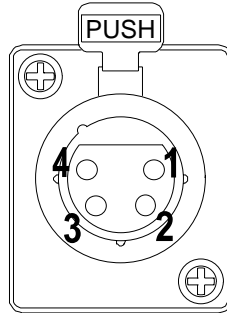

■ DC 24V OUT Connector Pin Assignment Table
(4-pin power connector, female, Canon XLR 44-313 F77)

Pin NO.	Signal	Description
1	+24V DC OUT	24VDC, 2.5A, Capacitor resettable fuse
2	+24V DC OUT	
3	GND	Ground
4	GND	Ground



Caution

The maximum current supplied to the DC OUT connector is 2.5A.
Do not feed a current exceeding 2.5A.

If the fuse protection starts accidentally, disconnect the DC power cable from the unit, power off the unit and set it aside more than 5 minutes until it cools.

6. Specifications & Dimensions

6-1. TALOC Specifications

6-1-1. HVS-TALOC20/ HVS-TALOC32

CONTROL IN	RS-422 connector, 1 ea., 9-pin D-sub (female)
CONTROL OUT	RS-422 connector, 1 ea., 9-pin D-sub (female)
ALARM OUT	Round connector, 1 ea., 10-pin (female)
TALLY OUT	2 ea., 50-pin D-sub (female)
DC OUT	24VDC, 2.5A, 1ea., XLR 44-313 F77 (female) (Capacitor fused)
Power	100 VAC - 240 VAC \pm 10%, 50/ 60Hz
Consumption	If AC100V used: Approx.20VA (w/o load) Approx.90VA (at 2.5A) If AC220V used: Approx.25VA (w/o load) Approx.90VA (at 2.5A)
Temperature	0°C – 40°C
Humidity	30% – 90% (no condensation)
Dimensions	212 (W) x 44 (H) x 350 (D) mm
Weight	Approx. 2.5 kg

6-1-2. HVS-TALR20/ HVS-TALR32

CONTROL IN	RS-422 connector, 1 ea., 9-pin D-sub (female)
CONTROL OUT	RS-422 connector, 1 ea., 9-pin D-sub (female)
ALARM OUT	Round connector, 1 ea., 10-pin (female)
TALLY OUT	4 ea., 50-pin D-sub (female)
DC OUT	24VDC, 2.5A, 1ea., XLR 44-313 F77 (female) (Capacitor fused)
Power	100 VAC - 240 VAC \pm 10%, 50/ 60Hz
Consumption	If AC100V used: Approx.20VA (when all outputs are relay contact) Approx.90VA (at 2.5A) If AC220V used: Approx.25VA (when all outputs are relay contact) Approx.90VA (at 2.5A)
Temperature	0°C – 40°C
Humidity	30% – 90% (no condensation)
Dimensions	212 (W) x 44 (H) x 350 (D) mm
Weight	Approx. 3.0kg

6-2. External Dimensions

6-2-1. HVS-TALOC20/32

(All dimensions in mm.)

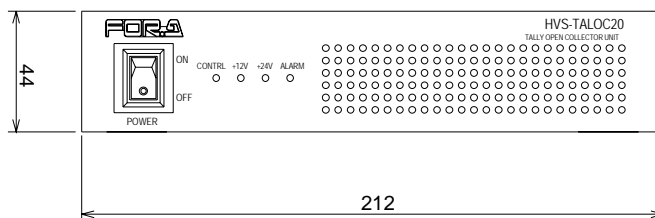
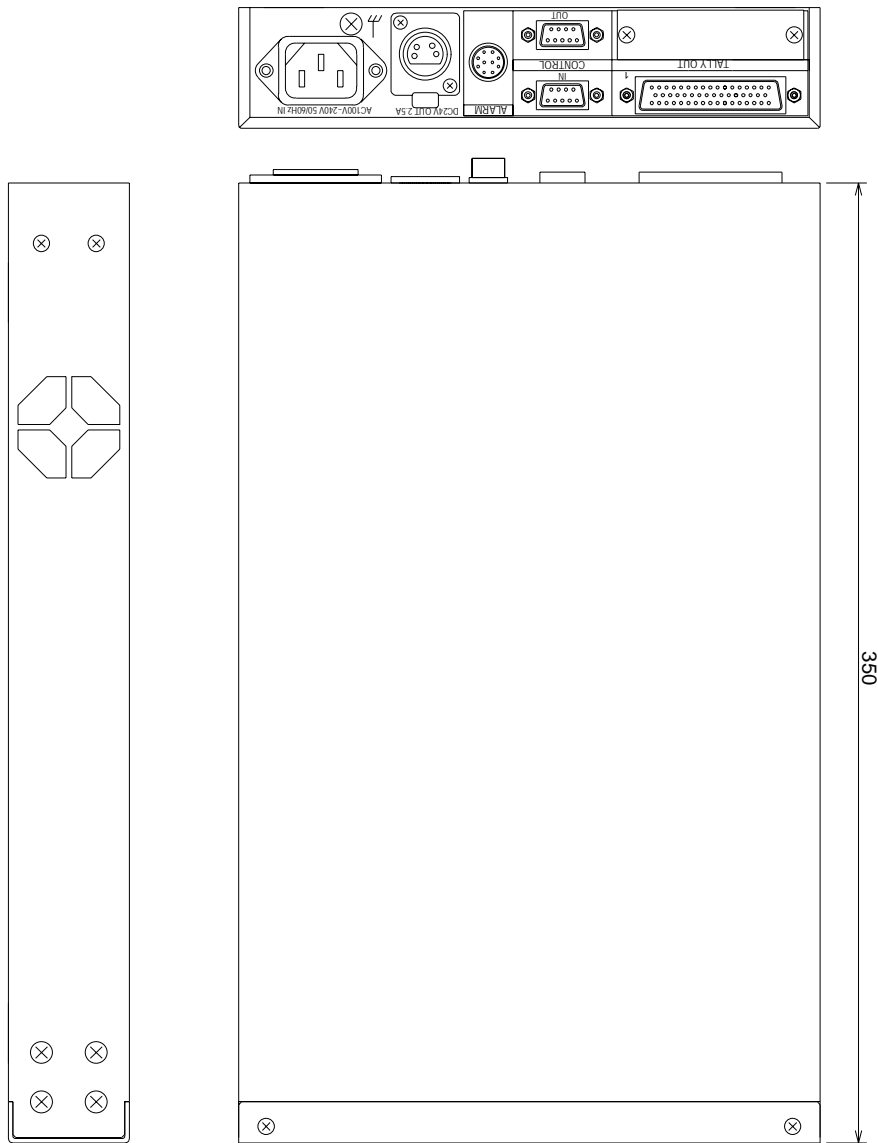

The HVS-TALOC20 and HVS-TALOC32 unit dimensions are identical.

6-2-2. HVS-TALR20/32

(All dimensions in mm.)

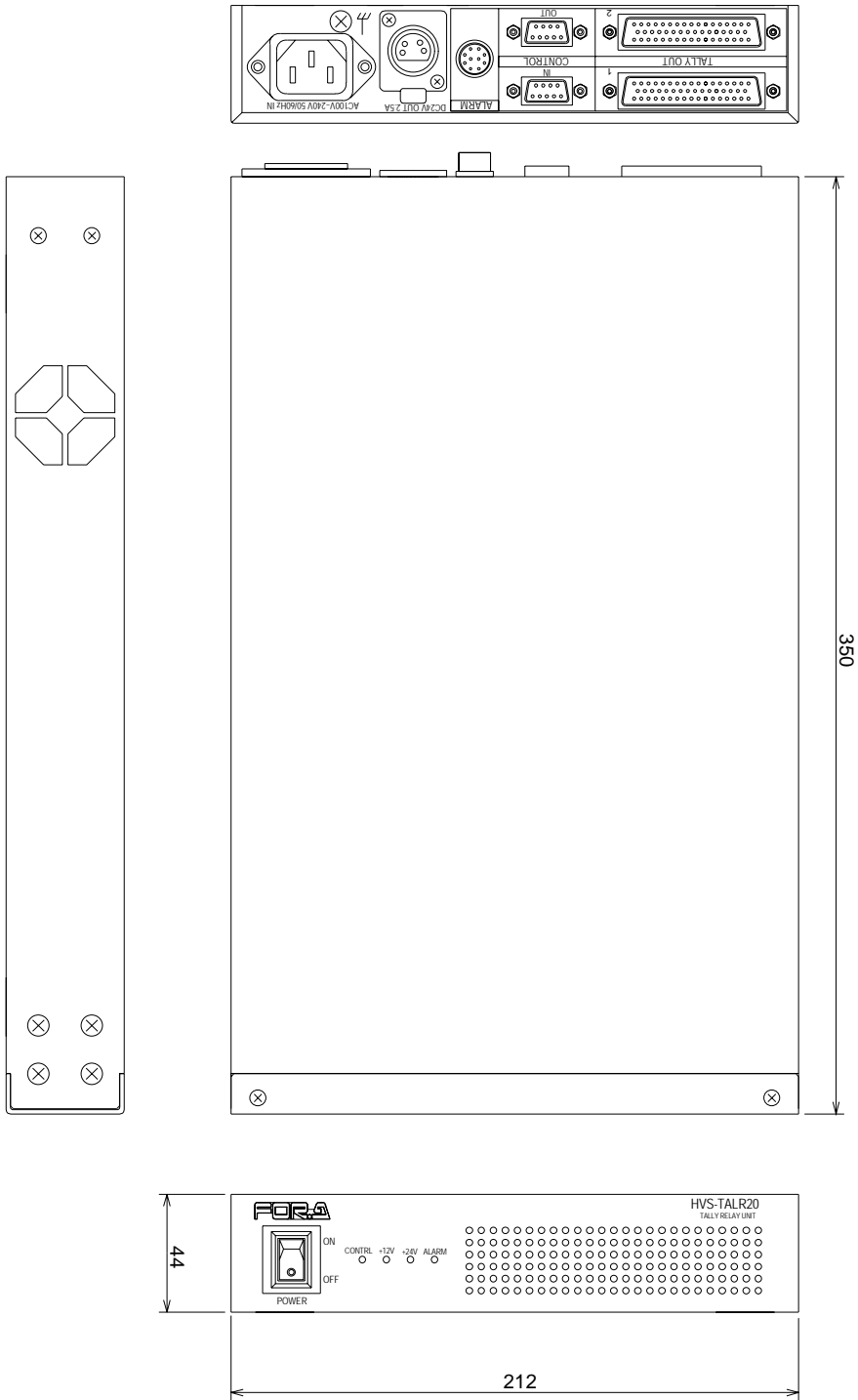

The HVS-TALR20 and HVS-TALR32 unit dimensions are identical.

Warning

This equipment has been tested and found to comply with the limits for a Class A digital device, pursuant to Part 15 of FCC Rules. These limits are designed to provide reasonable protection against harmful interference when the equipment is operated in a commercial environment. This equipment generates, uses, and can radiate radio frequency energy and, if not installed and used in accordance with the instruction manual, may cause harmful interference to radio communications. Operation of this equipment in a residential area is likely to cause harmful interference, in which case the user will be required to correct the interference at his own expense.



FOR-A COMPANY LIMITED

Head Office : 3-8-1 Ebisu, Shibuya-ku, Tokyo 150-0013, Japan
Overseas Division Phone: +81 (0)3-3446-3936, Fax: +81 (0)3-3446-1470
Japan Branch Offices : Osaka/Fukuoka/Hiroshima/Nagoya/Sendai/Sapporo
R&D/Production : Sakura Center/Sapporo Center/Florida Center/Los Angeles Center

FOR-A America Corporate Office

11125 Knott Ave., Suite #A, Cypress, CA 90630, U.S.A.
Phone : +1 714-894-3311 Fax : +1 714-894-5399

FOR-A America East Coast Office

1065 Avenue of the Americas Suite #1701A New York, NY 10018, U.S.A.
Phone : +1 212-861-2758 Fax : +1 212-861-2793

FOR-A America Distribution & Service Center

2400 N.E. Waldo Road, Gainesville, FL 32609, U.S.A.
Phone: +1 352-371-1505 Fax : +1 352-378-5320

FOR-A Corporation of Canada

425 Queen Street West, Suite 211, Toronto, Ontario M5V 2A5, CANADA
Phone: +1 416-977-0343 Fax : +1 416-977-0657

FOR-A UK Limited

UNIT C71, Barwell Business Park, Leatherhead Road, Chessington Surrey, KT9 2NY, U.K.
Phone: +44 (0)20-8391-7979 Fax : +44 (0)20-8391-7978

FOR-A Italia S.r.l.

Viale Europa 50 20093, Cologno Monzese (MI), Milan, ITALY
Phone: +39 02-254-3635/6 Fax : +39 02-254-0477

FOR-A Corporation of Korea

801 Dangsang Bld., 53-1 Dangsang-Dong, Youngdeungpo-Gu, Seoul 150-800, Korea
Phone: +82 (0)2-2637-0761 Fax : +82 (0)2-2637-0760