

OPERATION MANUAL

HVS-AUX16A
HVS-AUX32A
HVS-AUX64A
Auxiliary Unit

2nd Edition



Edition Revision History

Edit.	Rev.	Date	Description	Section/Page
1	-	2014/05/19		
2	-	2014/06/06	Supported HVS-390HS	



Precautions

Important Safety Warnings



[Power]

 Caution	Operate unit only at the specified supply voltage.
	Disconnect the power cord via the power plug only. Do not pull on the cable portion.
 Stop	Do not place or drop heavy or sharp-edged objects on the power cord. A damaged cord can cause fire or electrical shock hazards. Regularly check the power cord for excessive wear or damage to avoid possible fire / electrical hazards.

[Grounding]

 Caution	Ensure the unit is properly grounded at all times to prevent electrical shock.
 Hazard	Do not ground the unit to gas lines, units, or fixtures of an explosive or dangerous nature.
 Caution	Ensure the power cord is firmly plugged into the AC outlet.



[Operation]

 Hazard	Do not operate the unit under hazardous or potentially explosive atmospheric conditions. Doing so could result in fire, explosion, or other hazardous results.
 MHazard	Do not allow liquids, metal pieces, or other foreign materials to enter the unit. Doing so could result in fire, other hazards, or a unit malfunction.
	If a foreign material does enter the unit, turn the power off and immediately disconnect the power cord. Remove the material and contact an authorized service representative if damage has occurred.

[Transportation]

 Caution	Handle with care to avoid impact shock during transit, which may cause malfunction. When you need to transport the unit, use the original or suitable alternative packing material.
--	--

[Circuitry Access]

 A black circle with a white lightning bolt and a white 'E' with a horizontal line through it, indicating no power.	<p>Do not remove covers, panels, casing, or access the circuitry with power applied to the unit. Turn the power off and disconnect the power cord prior to removal. Internal servicing / adjustment of unit should only be performed by qualified personnel.</p>
 A black circle with a white hand and a diagonal slash through it, indicating no touch. Stop	<p>Do not touch any parts / circuitry with a high heat factor. Capacitors can retain enough electric charge to cause mild to serious shock, even after the power has been disconnected. Capacitors associated with the power supply are especially hazardous.</p>
 A black triangle with a white exclamation mark and a flame, indicating a hazard. Hazard	<p>Unit should not be operated or stored with cover, panels, and / or casing removed. Operating the unit with circuitry exposed could result in electric shock / fire hazards or a unit malfunction.</p>

[Potential Hazards]

 A black triangle with a white lightning bolt, indicating caution. Caution	<p>If abnormal odors or noises are noticed coming from the unit, immediately turn the power off and disconnect the power cord to avoid potentially hazardous conditions. If problems similar to the above occur, contact an authorized service representative before attempting to operate the unit again.</p>
---	---

[Rack Mount Brackets, Ground Terminal, and Rubber Feet]

 A black circle with a white exclamation mark, indicating caution. Caution	<p>To rack-mount or ground the unit, or to install rubber feet, do not use screws or materials other than those supplied. Doing so may cause damage to the internal circuits or components of the unit. If you remove the rubber feet that are attached to the unit, do not reinsert the screws that secure the rubber feet.</p>
--	--

[Consumables]

 A black triangle with a white exclamation mark, indicating caution. Caution	<p>Consumable items that are used in the unit must be periodically replaced. For further details on which parts are consumables and when they should be replaced, refer to the specifications at the end of the Operation Manual. Since the service life of the consumables varies greatly depending on the environment in which they are used, such items should be replaced at an early date. For details on replacing consumable items, contact your dealer.</p>
---	---

Upon Receipt

Unpacking

HVS-AUX16A, HVS-AUX32A and HVS-AUX64A units and their accessories are fully inspected and adjusted prior to shipment. Operation can be performed immediately upon completing all required connections and operational settings.

Check your received items against the packing lists below. Check to ensure no damage has occurred during shipment. If damage has occurred, or items are missing, inform your supplier immediately.

◆ HVS-AUX16A / 32A / 64A box

ITEM	QTY	REMARKS
HVS-AUX16A HVS-AUX32A HVS-AUX64A	1	
AC Adapter	1	
AC Cord	1 set	(with AC cord retaining clip)
Operation Manual	1	(This manual)

◆ User-supplied cable

ITEM	QTY	REMARKS
LAN cable	1	For switcher connection. For a hub connection, use a straight-through cable. For direct connection, use a cross-over cable.

DC Cord Clamp Installation

Insert the DC cord into the DC IN connector, then secure the cord with the DC cord clamp attached to the hole as shown in the figure.

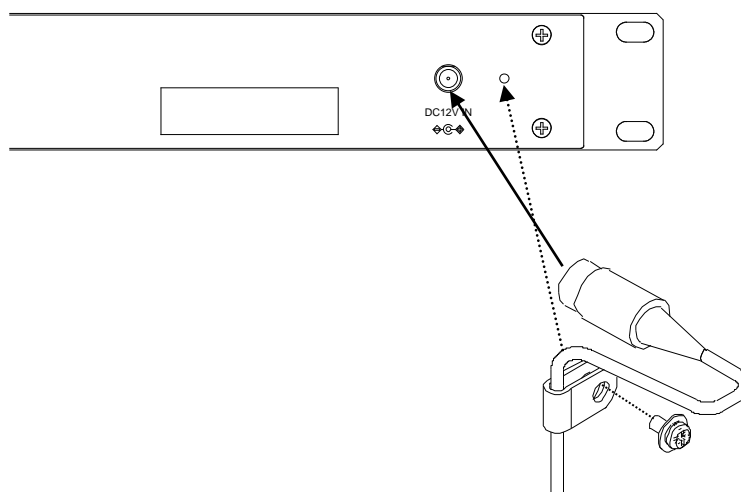

Table of Contents

1. Prior to Starting	7
1-1. Welcome	7
1-2. Features	7
2. Panel Descriptions	8
2-1. Front Panel.....	8
2-2. Rear Panel	9
3. Connection	10
3-1. Connecting HVS-XT100/110.....	10
3-2. Connecting HVS-390HS	11
4. Setup (Network Settings)	12
4-1. SETUP Menu	12
4-2. Connecting a Single AUX Unit to a Switcher	12
4-3. Connecting Two or More AUX Units to a Switcher.....	13
4-3-1. Changing the AUX Unit IP Address.....	13
4-3-2. Changing the AUX ID Number.....	14
4-4. LOCK (Front Panel Lock).....	14
5. Specifications and Dimensions	15
5-1. Unit Specifications.....	15
5-2. External Dimensions	15
5-2-1. HVS-AUX16A.....	15
5-2-2. HVS-AUX32A.....	16
5-2-3. HVS-AUX64A.....	16

1. Prior to Starting

1-1. Welcome

Congratulations! By purchasing an HVS-AUX16A / HVS-AUX32A / HVS-AUX64A you have entered the world of FOR-A and its many innovative products. Thank you for your patronage and we hope you turn to FOR-A products again and again to satisfy your video and audio needs. FOR-A provides a wide range of products, from basic support units to complex system controllers, which have been increasingly joined by products for computer video-based systems. Whatever your needs, talk to your FOR-A representative. We will do our best to be of continuing service to you.

1-2. Features

Auxiliary Units, HVS-AUX16A, HVS-AUX32A and HVS-AUX64A, are designed to remotely control M/E (PGM/PST) and auxiliary outputs of the Hanabi series switchers

◆ Supported Switchers

Switcher	Max. Connections
HVS-XT100/110	5 units
HVS-390HS	10 units

- All buttons are user assignable: 16, 32 and 64 buttons respectively on HVS-AUX16A, HVS-AUX32A and HVS-AUX64A
- AUX front panel LOCK function
- Multiple AUX units connection available through an Ethernet Hub

2. Panel Descriptions

2-1. Front Panel

◆ HVS-AUX16A

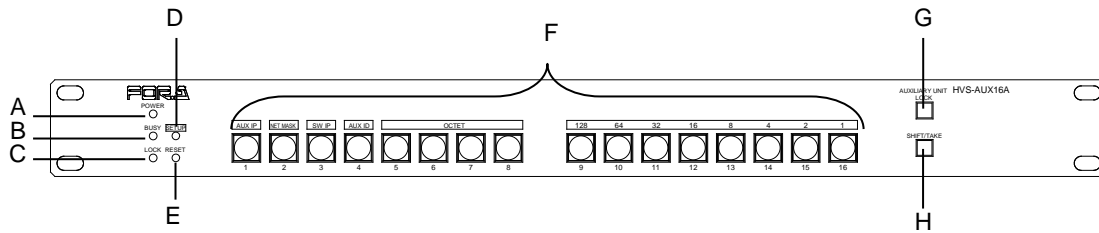

◆ HVS-AUX32A

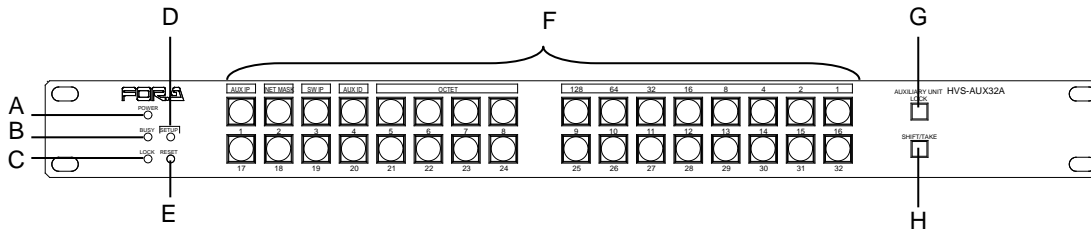

◆ HVS-AUX64A

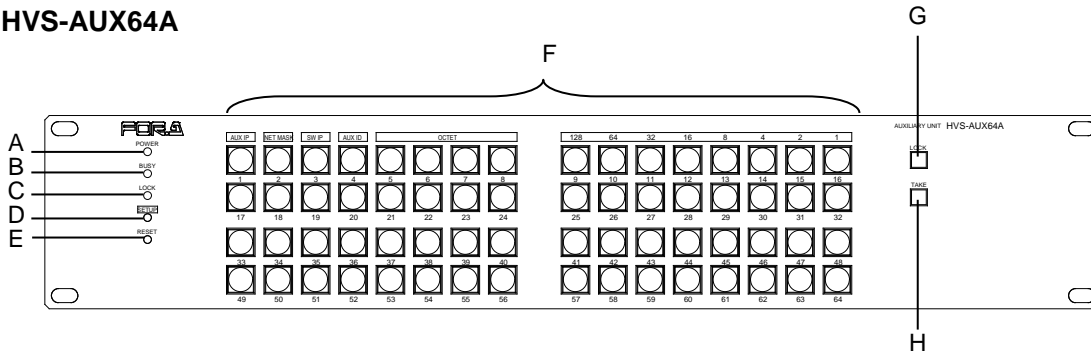

Letter	Name	Description
A	POWER	Displays the power status. ▶ See the table on the next page for details on indications.
B	BUSY	Displays the flash memory writing status for backup settings. ▶ See the table on the next page for details on indications.
C	LOCK	Displays the LOCK status. ▶ See the table on the next page for details on indications. ▶ See section 4-4. "LOCK (Front Panel Lock)" for details on the lock function.
D	SETUP	Used to set IP address or other settings. ▶ See section 4-1 "SETUP Menu" for SETUP menu details.
E	RESET	Used to re-initialize the AUX Unit.
F	Buttons	All buttons are user assignable. (Buttons turn green when selected.)
G	LOCK	Used to disable switcher control from the AUX Unit.
H	SHIFT/TAKE	Used as an assignable SHIFT or TAKE button on the switcher. (Only TAKE can be assigned on HVS-AUX64A units.)

◆ LED Color indications

LED \ LED color	Green	Red	Orange	Unlit
POWER	Normal			
BUSY	Normal processing		Writing to flash memory	Un-connected to the switcher
LOCK		Unit locked		Unit unlocked

* All indicators, POWER, BUSY and LOCK, light orange when the SETUP menu is displayed.

IMPORTANT

Do not power OFF the unit while BUSY LED is lit orange

◆ Changing Button Labels

Button labels can be changed for user-assignable buttons. Download and use the appropriate label template from the FOR-A Website product page. (See the back cover.)

2-2. Rear Panel

◆ HVS-AUX16A/32A/64A



Letter	Name	Description
A	LAN	For switcher connection Ethernet port (100BASE-TX, RJ-45)
B	DC12V IN	12 V DC power inlet

3. Connection

3-1. Connecting HVS-XT100/110

The example system shown below an HVS-AUX16A connects to and remotely controls a switcher (HVS-XT100 with HVS-XT100OU)

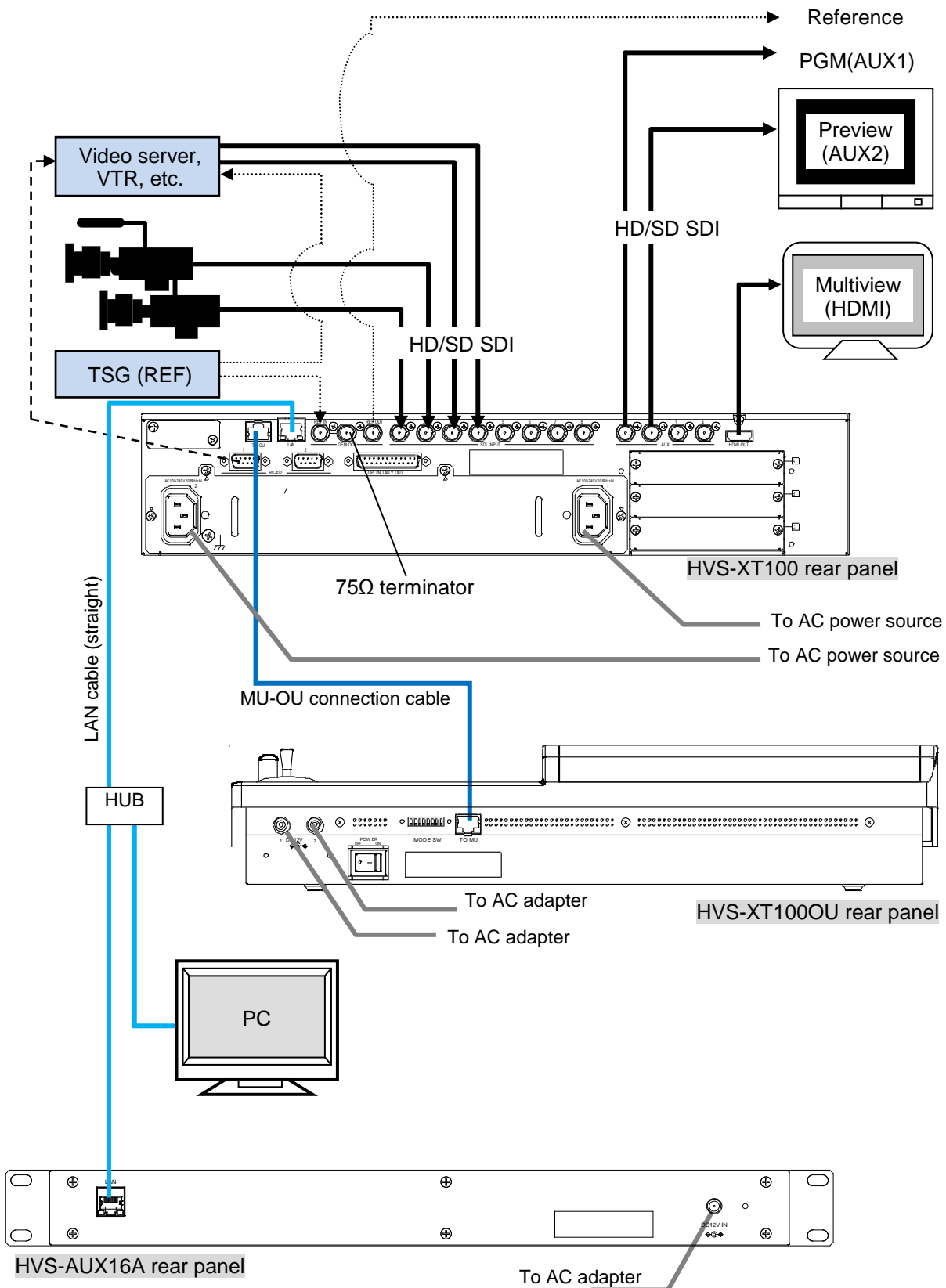

3-2. Connecting HVS-390HS

The example system shown below an HVS-AUX16A connects to and remotely controls a switcher (HVS-390HS with HVS-392OU)

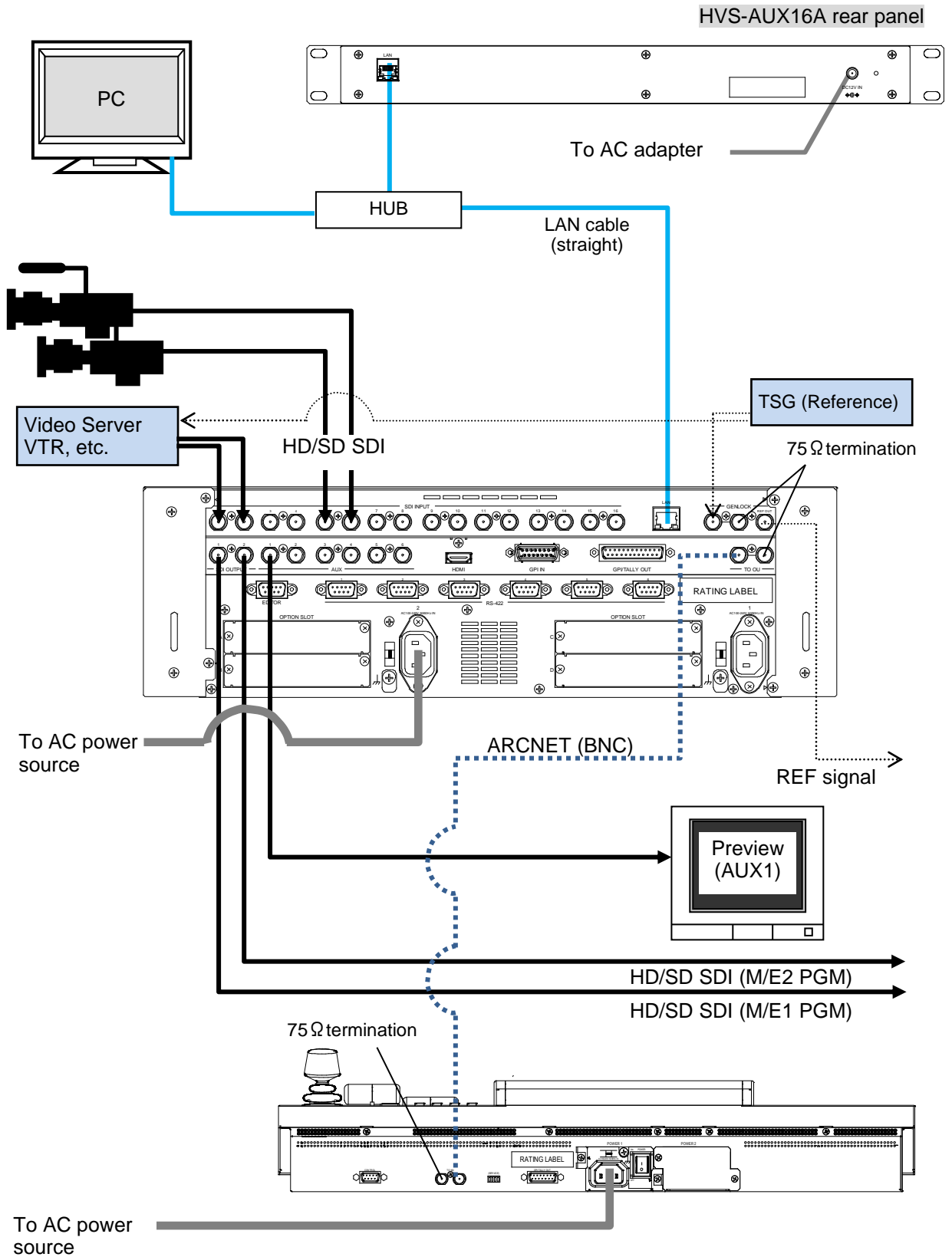

4. Setup (Network Settings)

Network settings should be changed for multiple AUX units connected to a switcher, since identical IP addresses within a network are not allowed.

IMPORTANT

Note that no AUX Unit button functions are assigned as the factory default.
Assign button functions to buttons from the menu on the connected switcher. See your switcher's Operation Manual for more details.

4-1. SETUP Menu

The **SETUP** button allows you to enter **Setup Menu** mode, in which AUX Unit network settings can be displayed and changed. The left four buttons are used to select information to be displayed. To exit Setup Menu mode, press the **SETUP** button again.

Button name	Default setting	Description
AUX IP	192.168.0.20	Sets the AUX Unit IP address.
NETMASK	255.255.255.0	Sets the AUX Unit Netmask.
SW IP	192.168.0.10	Specifies the IP address of the switcher to be connected.
AUX ID	1	Sets the AUX Unit ID number.

4-2. Connecting a Single AUX Unit to a Switcher

◆ Connection Example

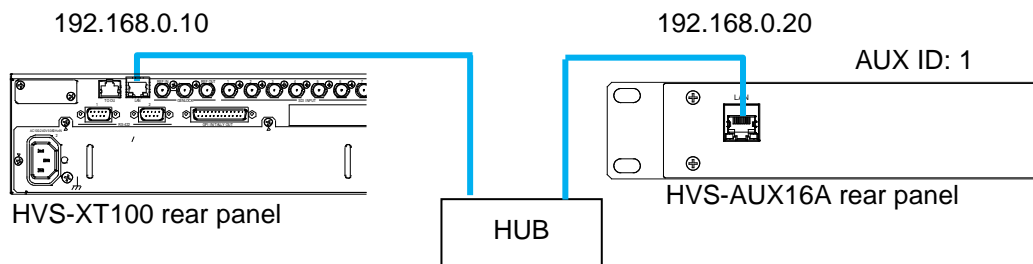

No network settings are required. Connect and use your AUX Unit under the factory default settings.

4-3. Connecting Two or More AUX Units to a Switcher

◆ Connection Example

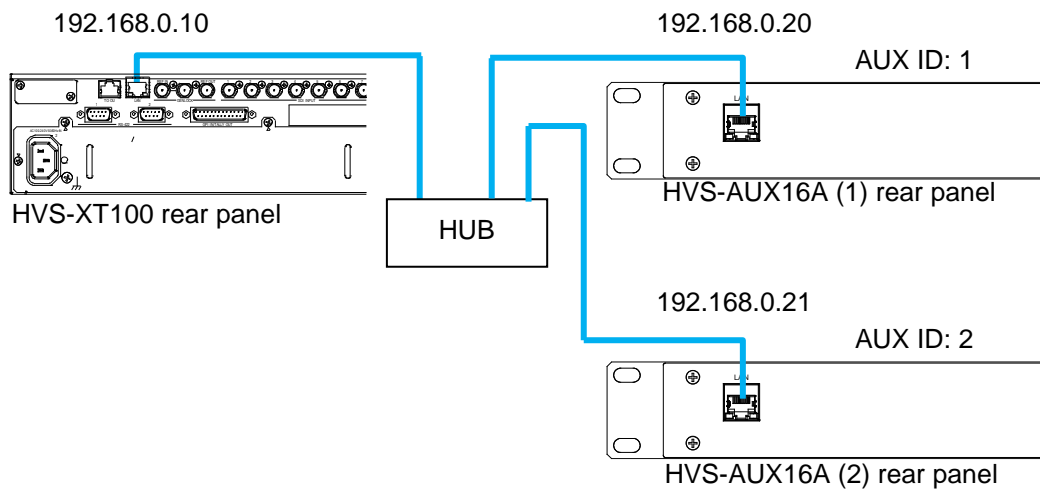

When connecting two or more AUX Units to a switcher, each AUX Unit should have a different IP address and AUX ID number. Refer to the following sections to change these settings.

4-3-1. Changing the AUX Unit IP Address

The following setting procedure changes the IP address of HVS-AUX16A (2) in the above figure example, from **192.168.0.20** to **192.168.0.21**.

- (1) Press **SETUP**. All indicators turn orange and indicate that the AUX Unit is in menu SETUP mode.
- (2) Press **AUX IP**.
- (3) To obtain the current IP address, respectively press Buttons **5** to **8**, which represent each octet of the IP address. Each octet number will be displayed on Buttons **9** to **16** in binary mode: On or Off.

IP address	1 st octet	2 nd octet	3 rd octet	4 th octet
192.168.0.20	192	168	0	20

- (4) **Press and hold down** **8** (the fourth octet button). The button will blink.
- (5) To change the fourth octet number, use **9** to **16**. In this example, the number should be changed from **20** to **21** (16+4+1), then turn the buttons on or off as shown in the figure below: **off, off, off, on, off, on, off, on**.
- (6) Once the IP address is changed, **LOCK** will blink. **Press and hold down** **LOCK** to confirm the change. The AUX Unit will automatically reset. (To cancel the process, press **SHIFT/TAKE** without pressing **LOCK**.)
To return settings to default, press and hold down **AUX IP**.

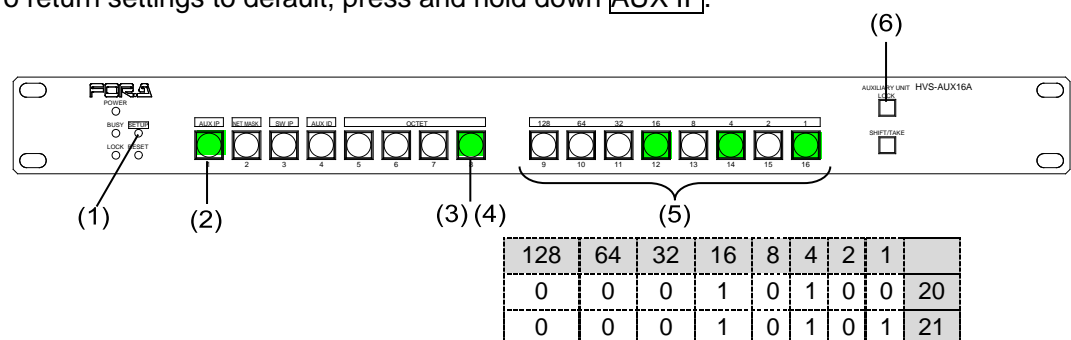

- (7) To verify the change, press **SETUP**, **AUX IP**, and then **8**.
 Check whether Buttons **9** to **16** show number “21” in binary mode.

* Use the same procedure to change NETMASK or SW IP, as necessary.

4-3-2. Changing the AUX ID Number

- (1) Press **SETUP**. All indicators turn orange to indicate the AUX Unit is in SETUP menu mode.
- (2) Press **AUX ID**.
- (3) The current AUX ID number will be displayed on Buttons **9** to **16** in binary mode: On or Off.
- (4) **Press and hold down 5**. The button will blink.
- (5) To change the ID number, use **9** to **16**. In this example, the number should be changed from 1 to 2, then turn the buttons on or off as shown in the figure below: **off, off, off, off, off, off, on, off**.
- (6) Once the ID number is changed, **LOCK** will blink. **Press and hold down LOCK** to confirm the change. The AUX unit will automatically reset. (To cancel the process, press **SHIFT/TAKE** without pressing **LOCK**.)
 To return settings to defaults, press and hold down **AUX IP**.

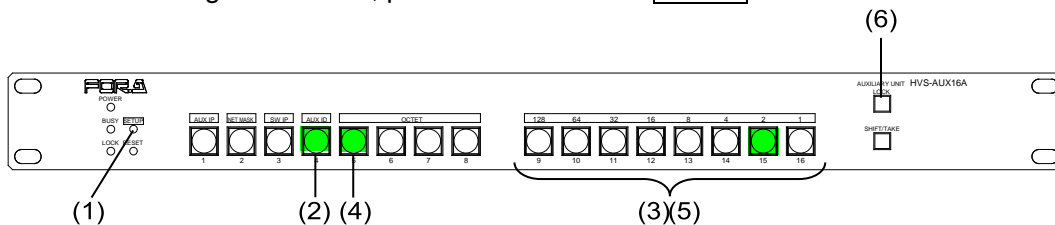

- (7) To verify the change, press **SETUP**, then **AUX ID**.
 Check whether Buttons **9** to **16** show number “2” in binary mode (see the figure above).

4-4. LOCK (Front Panel Lock)

The LOCK function allows you to disable AUX Unit front panel control.

◆ **To disable front panel operation:**

Press and hold **LOCK** down for 3 or more seconds until the button blinks.
 The LOCK indicator also blinks red and panel control is disabled.

◆ **To unlock the front panel:**

Press and hold **LOCK** down for 3 or more seconds until the button turns off.
 The LOCK indicator also turns off and panel control is enabled.

5. Specifications and Dimensions

5-1. Unit Specifications

		HVS-AUX16A	HVS-AUX32A	HVS-AUX64A
Free Buttons		16	32	64
LOCK button		Available	Available	Available
SHIFT/TAKE button		Available	Available	TAKE only
Interface (LAN)		100BASE-TX RJ-45 x 1 (For switcher connection. Hub required for multiple units connection)		
Temperature		0°C to 40°C		
Humidity		30% to 85% (no condensation)		
Power		+12 V DC, Pin connector x 1		
Consumption	AC100-120V	8VA (3W)	10VA (4W)	15VA (7W)
	AC220-240V	11VA (3W)	13VA (4W)	20VA (8W)
Dimensions		480(W) x 44(H) x 27(D) mm EIA1RU		480(W) x 88(H) x 27(D) mm EIA2RU
Weight		1 kg		1.5 kg
Consumables		AC adapter: Replace every 5 years		

5-2. External Dimensions

5-2-1. HVS-AUX16A

(All dimensions in mm.)

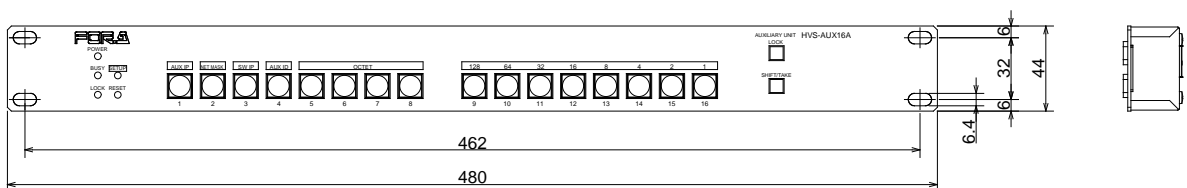
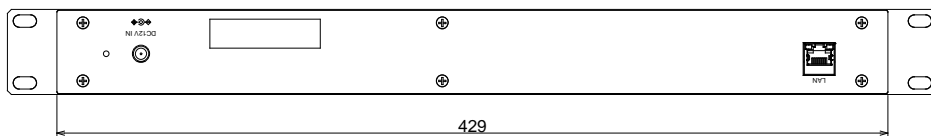

5-2-2. HVS-AUX32A

(All dimensions in mm.)

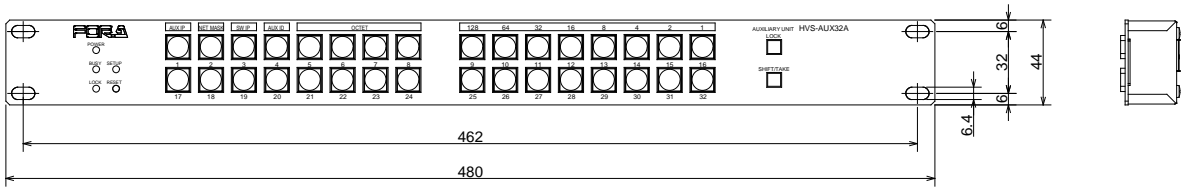
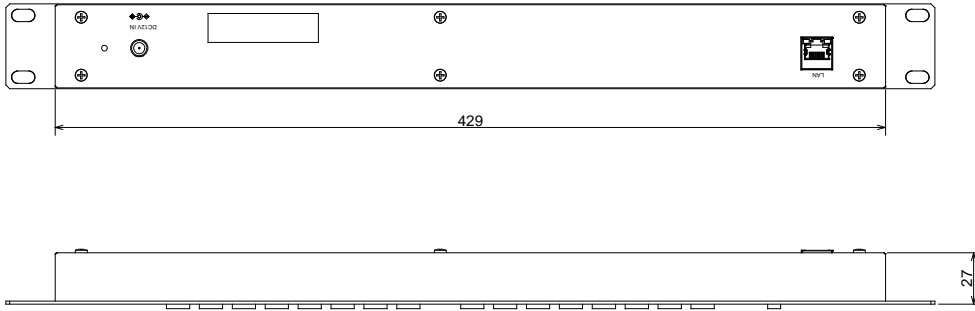

5-2-3. HVS-AUX64A

(All dimensions in mm.)

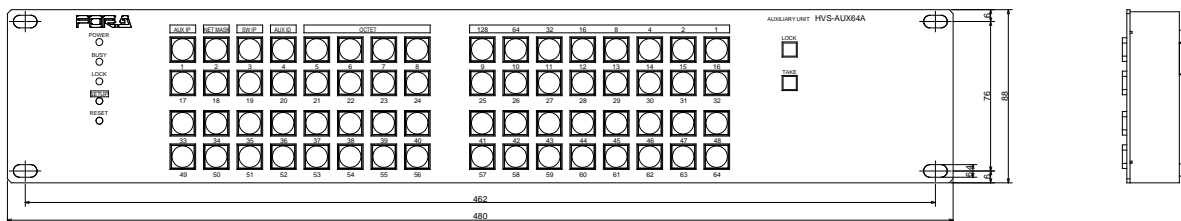
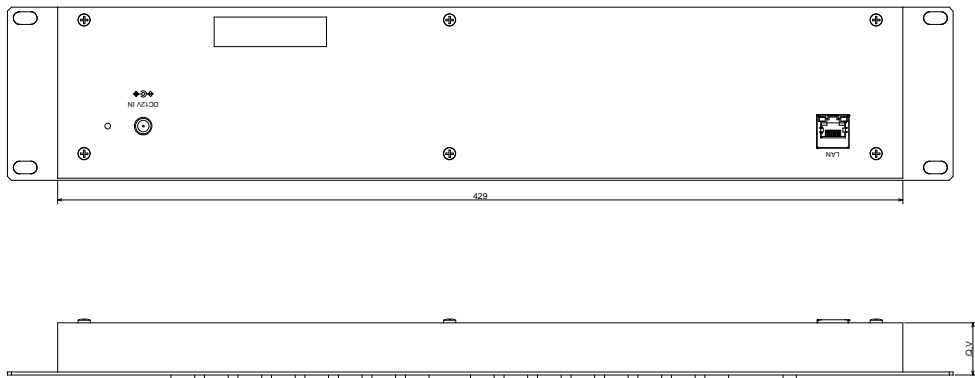

Warning

This equipment has been tested and found to comply with the limits for a Class A digital device, pursuant to Part 15 of FCC Rules. These limits are designed to provide reasonable protection against harmful interference when the equipment is operated in a commercial environment. This equipment generates, uses, and can radiate radio frequency energy and, if not installed and used in accordance with the instruction manual, may cause harmful interference to radio communications. Operation of this equipment in a residential area is likely to cause harmful interference, in which case the user will be required to correct the interference at his own expense.



FOR-A COMPANY LIMITED

Head Office 3-8-1 Ebisu, Shibuya-ku, Tokyo 150-0013, Japan
Overseas Division Phone: +81(0)3-3446-3936, Fax: +81(0)3-3446-1470
Japan Branch Offices Osaka/Okinawa/Fukuoka/Hiroshima/Nagoya/Sendai/Sapporo
R&D/Production Sakura Center/Sapporo Center

FOR-A America Corporate Office

11155 Knott Ave., Suite G&H, Cypress, CA 90630, USA
Phone: +1-714-894-3311 Fax: +1-714-894-5399

FOR-A America East Coast Office

2 Executive Drive, Suite 670, Fort Lee Executive Park, Fort Lee, NJ 07024, USA
Phone: +1-201-944-1120 Fax : +1-201-944-1132

FOR-A America Distribution & Service Center

2400 N.E. Waldo Road, Gainesville, FL 32609, USA
Phone: +1-352-371-1505 Fax: +1-352-378-5320

FOR-A Corporation of Canada

346A Queen Street West, Toronto, Ontario M5V 2A2, Canada
Phone: +1-416-977-0343 Fax: +1-416-977-0657

FOR-A Latin America & the Caribbean

5200 Blue Lagoon Drive, Suite 760, Miami, FL 33126, USA
Phone: +1-305-931-1700 Fax: +1-305-264-7890

FOR-A Europe S.r.l.

Via Volturmo 37, 20861 Brugherio MB, Italy
Phone: +39-039-879-778 Fax:+39-039-878-140

FOR A UK Limited

Trident Court, 1 Oakcroft Road, Chessington, KT9 1BD, United Kingdom
Phone: +44 (0)20-3044-2935 Fax: +44(0)20-3044-2936

FOR-A Italia S.r.l.

Via Volturmo 37, 20861 Brugherio MB, Italy
Phone: +39-039-881-086/103 Fax: +39-039-878-140

FOR-A Corporation of Korea

1007, 57-5, Yongsan-ro, Yeongdeungpo-gu, Seoul 150-103, Korea
Phone: +82(0)2-2637-0761 Fax: +82(0)2-2637-0760

FOR-A China Limited

708B Huateng Bldg., No. 302, 3 District, Jinsong, Chaoyang, Beijing 100021, China
Phone: +86(0)10-8721-6023 Fax: +86(0)10-8721-6033

FOR-A Middle East-Africa Office

Jebel Ali Free Zone, LOB-16, Office 619, P. O. Box: 261914 Dubai, UAE
Phone: +971 4 887 6712 Fax: +971 4 887 6713