

Simple Titler

CG-Portable/CG-Portable-A

FOR.A[®]

SIMPLE TITLER

CG-PORTABLE CG-PORTABLE-A



CG-PORTABLE/CG-PORTABLE-A

Compact, simple titler that is cost efficient and streamlined.

Can superimposes text*1 or logos. The cost-effective CG-Portable includes select features within a compact, palm-sized frame. CG-Portable-A supports HDMI output, which enables it to utilize a wide range of professional video equipment.

*1 True font is available. (Please check with the font provider for font licensing)

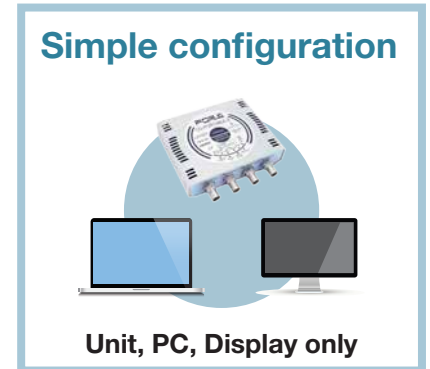
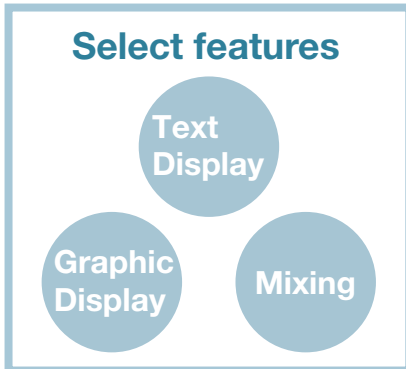

Two models lineup

	CG-Portable	CG-Portable-A
3G/HD-SDI input/output	○	○
HDMI output	-	○
3G/HD-SDI→HDMI conversion	-	○
On/Off remote control *2	-	○

*2 Commercial remote control unit required

Front side • Rear side

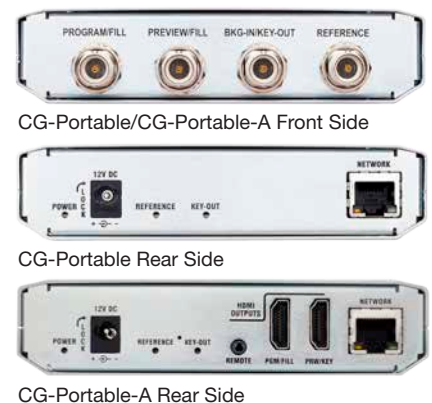

Displays text and graphics simultaneously



Graphics

- Logos • Animation Logos • IMAG

Two independent text

- Vertical and Horizontal
- Fix, horizontal crawl and vertical roll
- Independent multi-lingual support for text overlay

Features

- Embedded audio supported: Blank, Pass, Mute.
- Two modes installed:
internal mixing mode and fill/key output mode
- Fill and key mixing over live background video or uploaded graphics
- Static PNG /Animated logo insertion
- Over 70 frames of graphic playback buffer
- Ideal for a range of signage applications
- External reference input available
- Last page is shown after reboot

Operation images

Live Logo

Displays live logo or animation logo by using sequenced number files.



Sports

Displays TV station logo, watermark to broadcasting videos.



Commercials

Displays created commercial message. Enables adjustment of text size, color, roll and more.

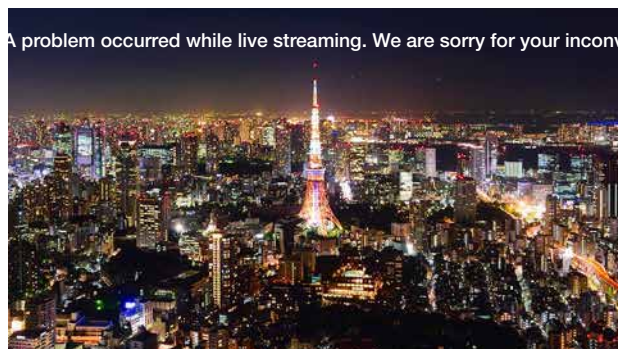

Streaming

Displays information for streaming videos of lectures or conferences.



Information display

Displays PNG file in digital signage.

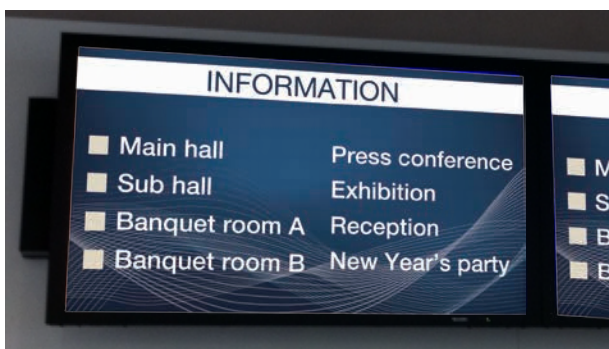

Message boards

Create a message board from output.

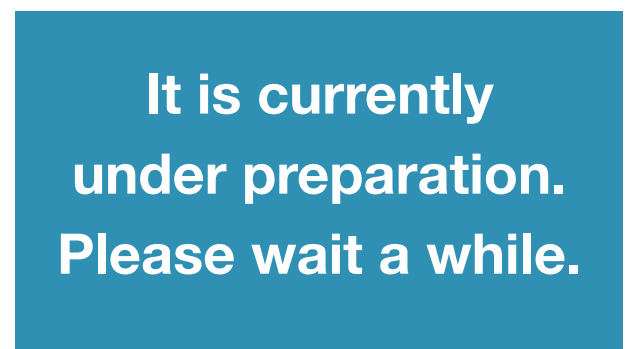

Water level information

River name, danger zone displayed with text and showing the water line



Censoring in Medical Field

Censoring personal information

Left: before censoring, Right: after censoring (yellow box)

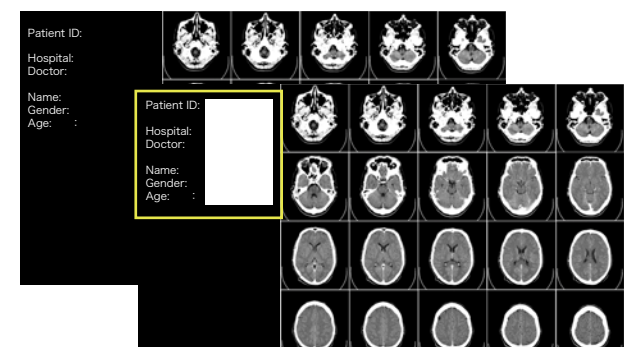

CG-PORTABLE/CG-PORTABLE-A

System examples

■ Add graphics to camera output

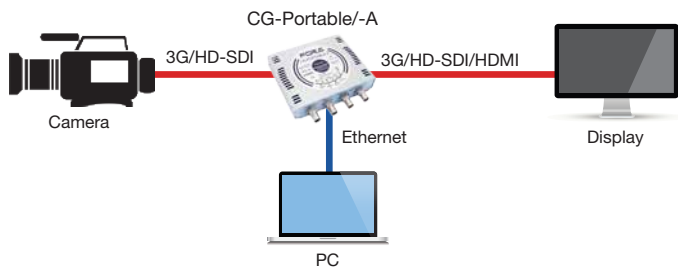

■ Control via LAN cable

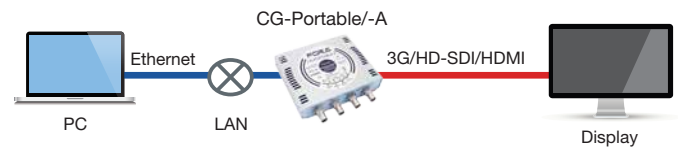

■ Utilize with FOR-A Video Switcher

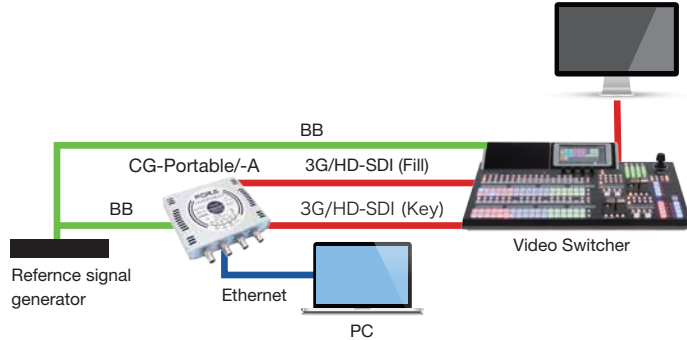

■ Remote control via Ethernet

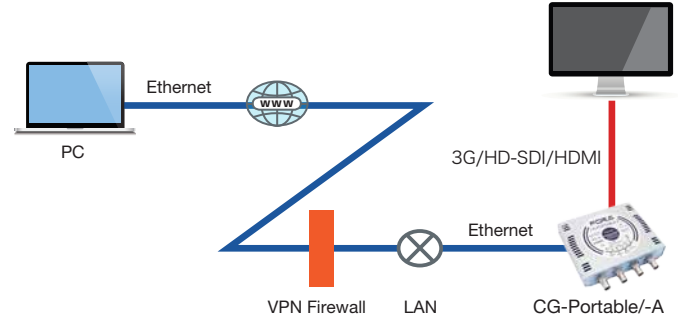

Specification

		CG-Portable	CG-Portable-A
Video Formats		3G-SDI: 1080/50p(Level-A/B), 1080/59.94p(Level-A/B), 1080/60p(Level-A/B) HD-SDI: 1080/50i, 1080/59.94i, 1080/60i, 1080/23.98p, 1080/24p, 1080/25p, 1080/29.97p, 1080/30p, 1080/23.98PsF, 1080/24PsF, 1080/25PsF, 1080/29.97PsF, 1080/30PsF	
Video Processing		10-bit; 4:2:2; YCbCr	
Video Input	BKG-IN	3G-SDI: 3 Gbps (Level-A/B), HD-SDI: 1.5 Gbps, 75Ω, BNC x 1 (Bi-directional BNC shared with KEY-OUT)*	
	REFERENCE	75Ω terminated BNC; HDTV Tri-sync/SD Bi-sync (black and burst) SMPTE 240M/274M	
Video Output	PROGRAM/FILL	3G-SDI: 3 Gbps (Level-A/B) HD-SDI: 1.5 Gbps, 75Ω, BNC x 1	3G-SDI: 3 Gbps (Level-A/B) HD-SDI: 1.5 Gbps, 75Ω, BNC x 1 HDMI: HDMI 1.4b
	PREVIEW/FILL	3G-SDI: 3 Gbps (Level-A/B) HD-SDI: 1.5 Gbps, 75Ω, BNC x 1	3G-SDI: 3 Gbps (Level-A/B) HD-SDI: 1.5 Gbps, 75Ω, BNC x 1 HDMI: HDMI 1.4b(Bi-directional HDMI shared with KEY-OUT)*
	KEY-OUT	3G-SDI: 3 Gbps (Level-A/B) HD-SDI: 1.5 Gbps, 75Ω, BNC x 1 (Bi-directional BNC shared with BKG-IN)	3G-SDI: 3 Gbps (Level-A/B) HD-SDI: 1.5 Gbps, 75Ω, BNC x 1 (Bi-directional BNC shared with BKG-IN)* HDMI: HDMI 1.4b(Bi-directional HDMI shared with PREVIEW)*
Audio		Embedded Audio. Blank, Pass, Mute	
I/O Delay (max)	Input locked to background	1080/23.98p, 1080/24p, 1080/25p, 1080/29.97p, 1080/30p: 36.9 μs 1080/23.98PsF, 1080/24PsF, 1080/25PsF, 1080/29.97PsF, 1080/30PsF: 37.0 μs 1080/50p(Level-A), 1080/59.94p(Level-A), 1080/60p(Level-A) : 17.7 μs 1080/50p(Level-B), 1080/59.94p(Level-B), 1080/60p(Level-B) : 71.2 μs 1080/50i, 1080/59.94i, 1080/60i: 34.5 μs	
Video Mixing	Keying	Output FILL & KEY/Self KEY	
	Transparency	From 0% to 100%	
	DSK mode	On: the unit generates Fill and Key outputs for use by a downstream keyer Off: text, graphic and timer elements are keyed over the Background input to generate Preview and Program outputs	
	Text background	Size and color selectable	
	Text outline	Off/on selectable width (0 to 30 pixels in steps of 1); color and opacity selectable	
Main Unit	Interface	LAN: 10/100BASE-TX, RJ-45 x 1	
	Temperature/humidity	0°C to 40°C/10% to 90% (no condensation)	
	Power	AC 100V-240V (50/60) Hz	
	Consumption	6W (at AC100V to 120V AC) 5.69W (AC220V to 240V AC) via 2.1mm ring lock connector	
	Dimensions/weight	125.5 (W) x 102.0 (D) x 28.5 (H) mm / 0.410 kg	
	Consumables/replacement timing (under constant use at room temperature)	Power unit/approx. 5 years	
	Included accessories	Operation manual (CD-ROM), Power unit	

* Switchable by DSK mode

FOR-A® Head Office: 3-8-1 Ebisu, Shibuya-ku, Tokyo 150-0013, Japan

FOR-A Corporation of America
Corporate Office/Service Center: Tel: +1 714-894-3311
11155 Knott Ave., Suite G, H & I, Cypress, CA 90630, U.S.A.

FOR-A Corporation of America Northeast Office: Tel: +1 973-220-8471
1360 Clifton Ave., Clifton, NJ 07012, U.S.A.

FOR-A Corporation of America Southeast Office: Tel: +1 305-773-7608

FOR-A Corporation of America Support Center: Tel: +1 352-371-1505
2400 N.E. Waldo Road, Gainesville, FL 32609, U.S.A.

FOR-A Latin America and the Caribbean Miami Office: Tel: +1 657-600-5759

FOR-A Latin America and the Caribbean Sao Paulo Office: Tel: +55 (0)11-99913-3751

FOR-A Europe S.r.l.: Tel: +39 039-916-4811
Via Volturmo, 37, 20861 Brughiero MB, Italy

FOR-A UK Limited: Tel: +44 (0)20-3044-2935
Trident Court, 1 Oakcroft Road, Chessington, KT9 1BD, UK

FOR-A Italia S.r.l.: Tel: +39 039-881-086/103
Via Volturmo, 37, 20861, Brughiero MB, Italy

FOR-A Corporation of Korea: Tel: +82 (0)2-2637-0761
1007, 57-5, Yangsan-ro, Yeongdeungpo-gu, Seoul 07271, Korea

FOR-A China Limited: Tel: +86 (0)10-8721-6023
1618 Huateng Building, No. 302, 3 District, Jinsong, Chaoyang, Beijing 100021, China

FOR-A Middle East-Africa Office: Tel: +971 4-551-5830
DSC Tower, Office 207, Dubai Studio City, P.O. Box 502688, Dubai, UAE

FOR-A India Private Limited. Corporate Office: Tel: +91-120-04238674/+91-120-4252330
Unit No: 800, 8th Floor, World Trade Tower "B", C-1, Sector-16, Noida-201301, Uttar Pradesh, India

FOR-A India Private Limited. Mumbai Office: Tel: +91-022-49795570
202-203, 2nd Floor, Wellington Business Park No-01, Marol, Off, Andheri Kuria Road, Andheri East, Mumbai-400059, Maharashtra, India

FOR-A South East Asia Office: Tel: +852 2110-9227
Studio 09, Rm. A1, 3/F., Phase 1, Hang Fung Ind. Bldg., 2G Hok Yuen St., Hung Hom, Hong Kong

ISO 9001 and 14001 certified
(Sakura R&D)

www.for-a.com