

4K/12G/6G/3G/HD Video Switcher  
HVS-6000/6000M "HANABI"

FOR.A®

花火  
HANABI

4K/12G/6G/3G/HD Video Switcher  
**HVS-6000/6000M**

HANABI



Offering 4K UHD and 12G-SDI support, a maximum of 80 inputs/32 outputs or 64 inputs/48 outputs, the HVS-6000 is ideal when upgrading from HD to 4K UHD

Designed for use in 4K UHD systems, the HVS-6000 brings 12G-SDI compatibility to all inputs and outputs. Users can operate the unit in the same manner as current HD systems. In an era of video-over-IP, the HVS-6000 enables IP interfaces to be mounted on all I/O slots\*.

\* To be supported.



### 12G-SDI compatibility across all inputs and outputs

Build and use a 4K production system with the same number of connections, phase control, methods of adjustment, and fault-tolerant design as before. Compatible with existing HD equipment, the switcher ensures a smooth transition in equipment and operation, as you move to 4K or take on simulcast production.



### Extendability for IP support\*

Support for up to 80 inputs provides an ample quantity for future 8K production. Structurally, switcher design also accounts for planned input/output expansion cards for Media over IP. The HVS-6000 video switcher has outstanding expandability, including mixed production with IP video material. \* To be supported.



### Includes secondary M/E, four full functional keyers per M/E and 3D DVEs

Each M/E bus provides four full functional keyers, which can be used with 2D DVEs. 3D DVEs can be used for background graphics, enabling HD-quality 3D DVE transitions. Secondary M/E function can also be used for both HD and 4K UHD operation.



### Input/output conversion

Upconversion\* from HD to 4K on all inputs and downconversion\* from 4K to HD on all AUX outputs are supported. Compatible with existing HD systems, the switcher paves the way to 4K migration.

\*Optional.

## Ample bus output

In M/E output, four channels of direct M/E slot output and eight channels of re-entry output can be managed separately from re-entry channels. The switcher can be configured freely, up to the number of keys, as selected for background. M/Es can also be set up for output of recaptured material, applying unused keys or a secondary M/E for operation with 3 M/Es or more.

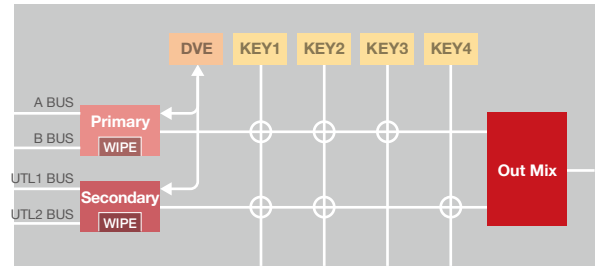

## Practical video memory

Data in video memory that is available for all Still and Clip operations is automatically backed up to internal storage. The switcher's memory is also equipped with a mechanism for sequential storage as each image is captured. Saved data is automatically restored when the switcher is turned on, eliminating the need to read material again, and streamlining operation.

## Versatile GUI for many switching styles

The control panel features a compact GUI on a 7-inch screen. Larger display and touch operations are possible by connecting an external monitor. By accessing the switcher from a Chrome web browser, users can also display a GUI panel enabling basic operations on a connected smartphone or tablet. This enables still image switching. PNG files can be uploaded with transparency, as edited on the smartphone or tablet. Password locking ensures security. What's more, the switcher is an excellent match for Gear-Link software, which consolidates operations of the switcher and external equipment in a single GUI.



## Solid performance with flexibility

Steady operation is ensured by separating real-time control and data transfer in switcher-panel connections. With six channels of serial ports, the synced control/connections for video router linkage, virtual studios, or peripherals are executed simultaneously and independently from current or reserved connections using one-touch controllers. Control can also be set up within an IP network. Tally lamps indicate calculation results for 24 channels in red, green, and so on. Tally input from external sources can be added to internal tally calculation. These features ensure flexibility in control and tallying when temporarily adding system equipment.

## Fault-tolerant design

Structurally, the switcher's power unit and each card (including input, output, M/Es, MTX, CPU, and genlock) slot in and are replaceable. For control panels, GUI and other operations such as button or fader, operations are processed by a separate CPU, enabling uninterrupted operation in case of a GUI failure. An external computer running GUI software can be connected as a backup. Additionally, the HVS-3355OU control panel enables redundant power supplies for line, aux, control, touch panel, and other system components. As an emergency feature in case of switcher failure, MFR routers are controlled by independent CPUs in line units via a dedicated connection. Each row of line units is independent and can also be used for backup. Button assignment in emergencies responds to the switcher bus (including shift bus) reassignment, ensuring a smooth switchover to emergency operation.

## Four types of control panels

The switcher is compatible with HVS-2000 control panels. Four options are available: the rack-sized HVS-2120ROU, two-bus HVS-2240OU, three-bus HVS-3320OU, and the HVS-3355OUA, with a custom-ordered amount of buttons, buses and fader layout. The panels offer customizable RGB button lights assigned to specific video material or button functions, a touch panel with GUI menus, and button/macro bus macro name display. Direct input is possible via a three-axis (XYZ) joystick, setting knobs, and a keypad. A larger GUI display is possible simply by connecting an external touchscreen monitor. A range of functions can also be assigned to user buttons on the control panel.

### HVS-2120ROU Control Panel

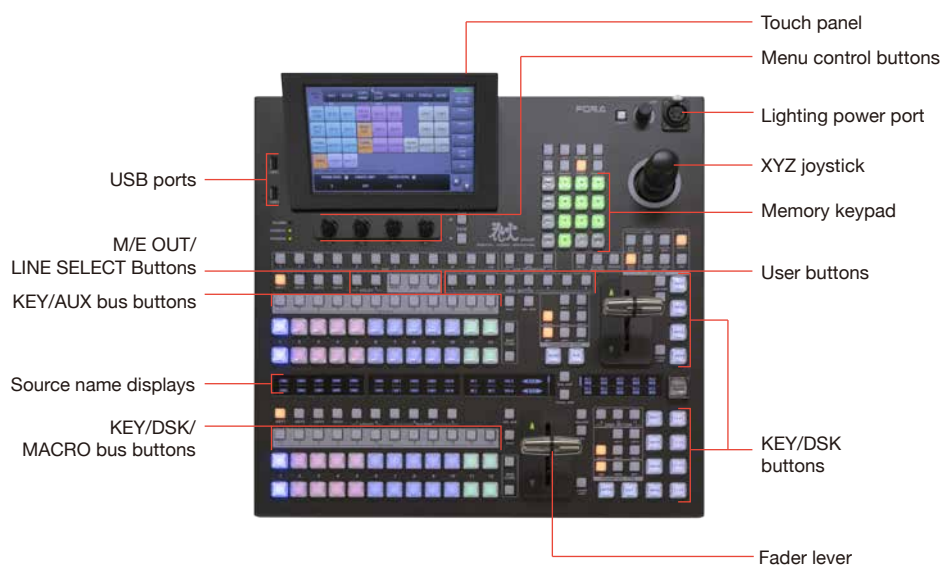

### HVS-2240OUA Control Panel

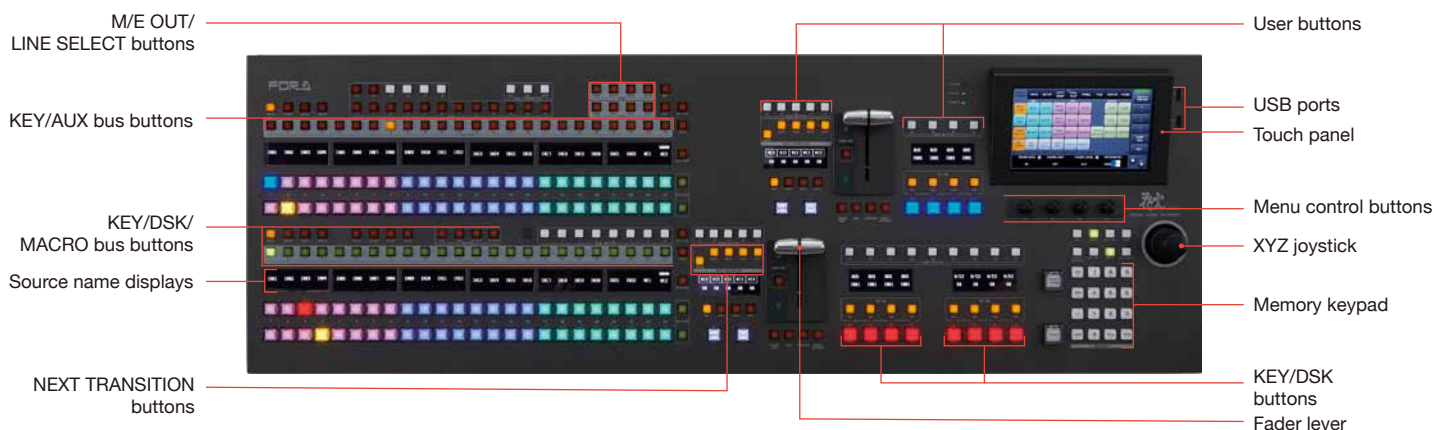

## HVS-33200U Control Panel

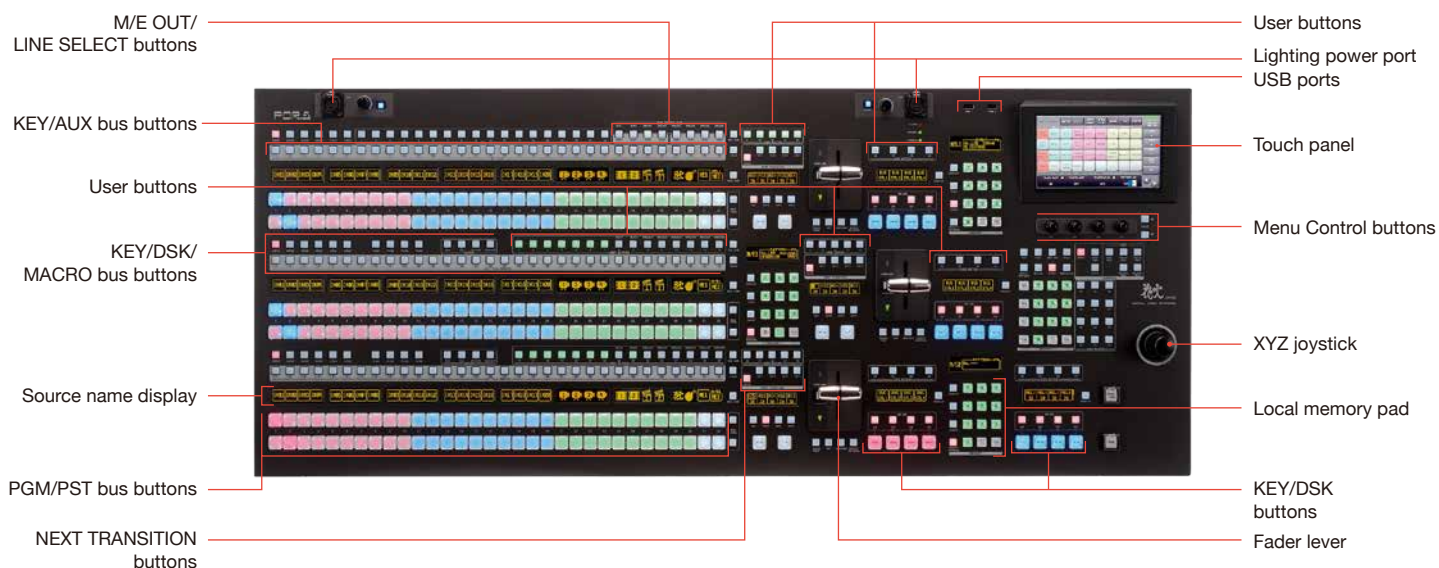

## HVS-33550UA Control Panel

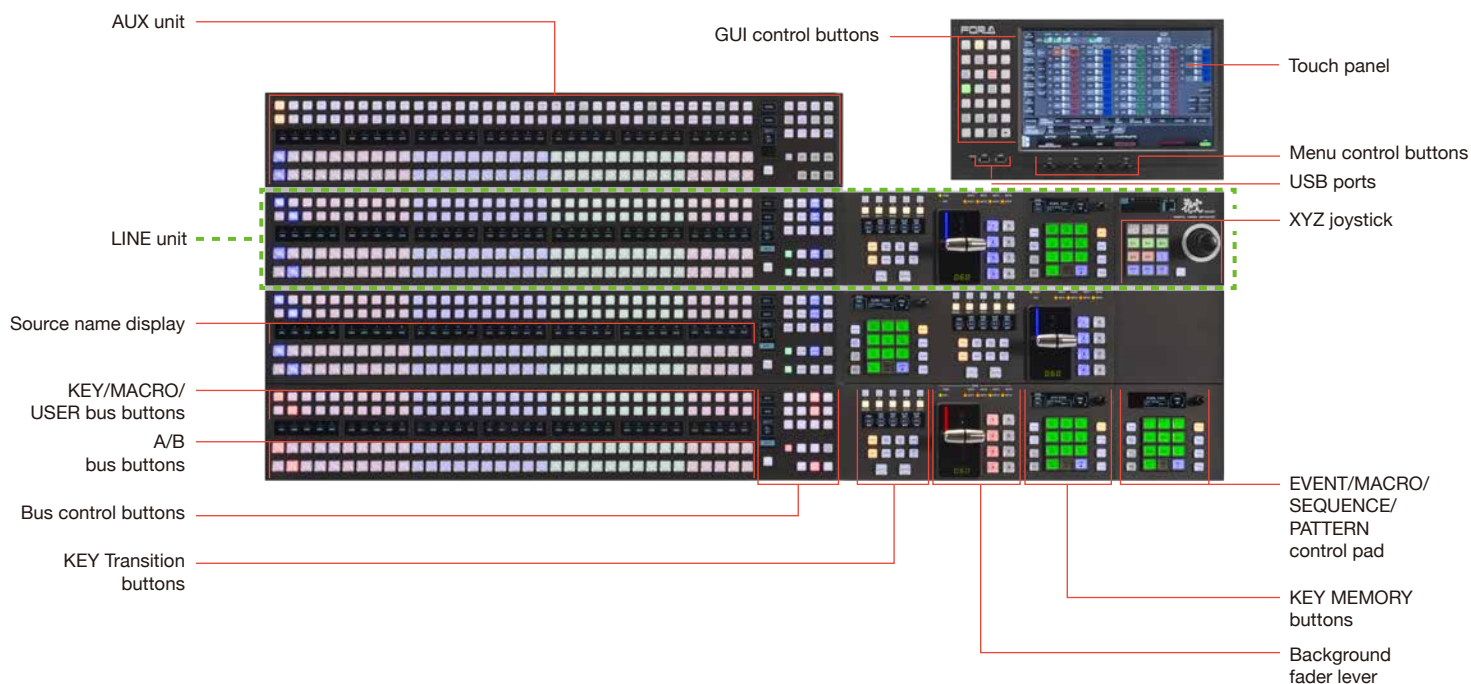

\*Control units and GUI units can be connected. Fader units, KEY units, number of M/Es and Control pad unit position can be customized. Please contact us for details.

## HVS-6000 Series Line-up



### HVS-6000

12RU enclosure with 5 input slots and 2 input/output slots. Can be expanded by 8 channels at a time with the addition of input or output expansion cards. 12G-SDI, expandable to up to 80 inputs/32 outputs or 64/48. A full-featured, expandable model for use as the primary switcher in studios or news control rooms.



### HVS-6000M

2 M/E switcher in a 7RU enclosure offering up to 32 inputs/24 outputs for 4K production. Useful not only in control rooms but also an excellent choice for mobile video production, thanks to a form factor that's less than 500mm deep. Brings full-scale 4K production within reach of many users.



(All specifications in below table are for 4K format.)

	HVS-6000	HVS-6000M
M/Es	2 M/Es standard, expandable to 4 <sup>*1</sup>	2 M/Es standard
Inputs	24 inputs standard, expandable to 80 <sup>*1</sup>	24 inputs standard, expandable to 32 <sup>*1</sup>
Outputs	24 outputs standard, expandable to 48 <sup>*1</sup>	24 outputs standard
AUX	16 standard, expandable to 32 <sup>*1</sup>	16 standard
Keyers	4 per M/E	
Still/Clip Stores	4 channels (with key): Approx. 30 sec. of shared uncompressed video memory	2 channels (with key): Approx. 30 sec. of shared uncompressed video memory
Conversion	Both upconversion* from HD to 4K and downconversion* from 4K to HD are available.	

\*1 Optional

## HVS-6000 Block Diagram

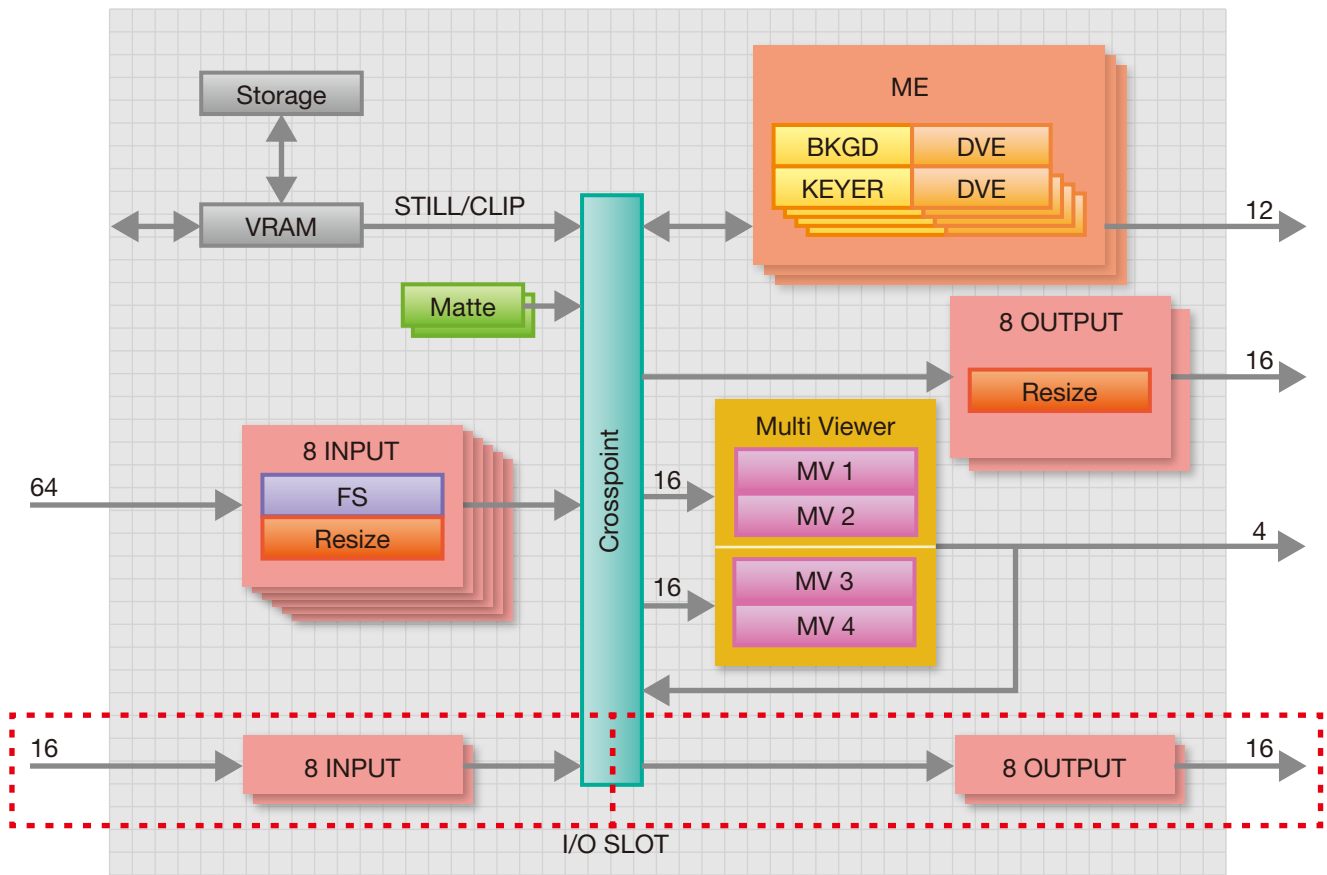

## HVS-6000M Block Diagram

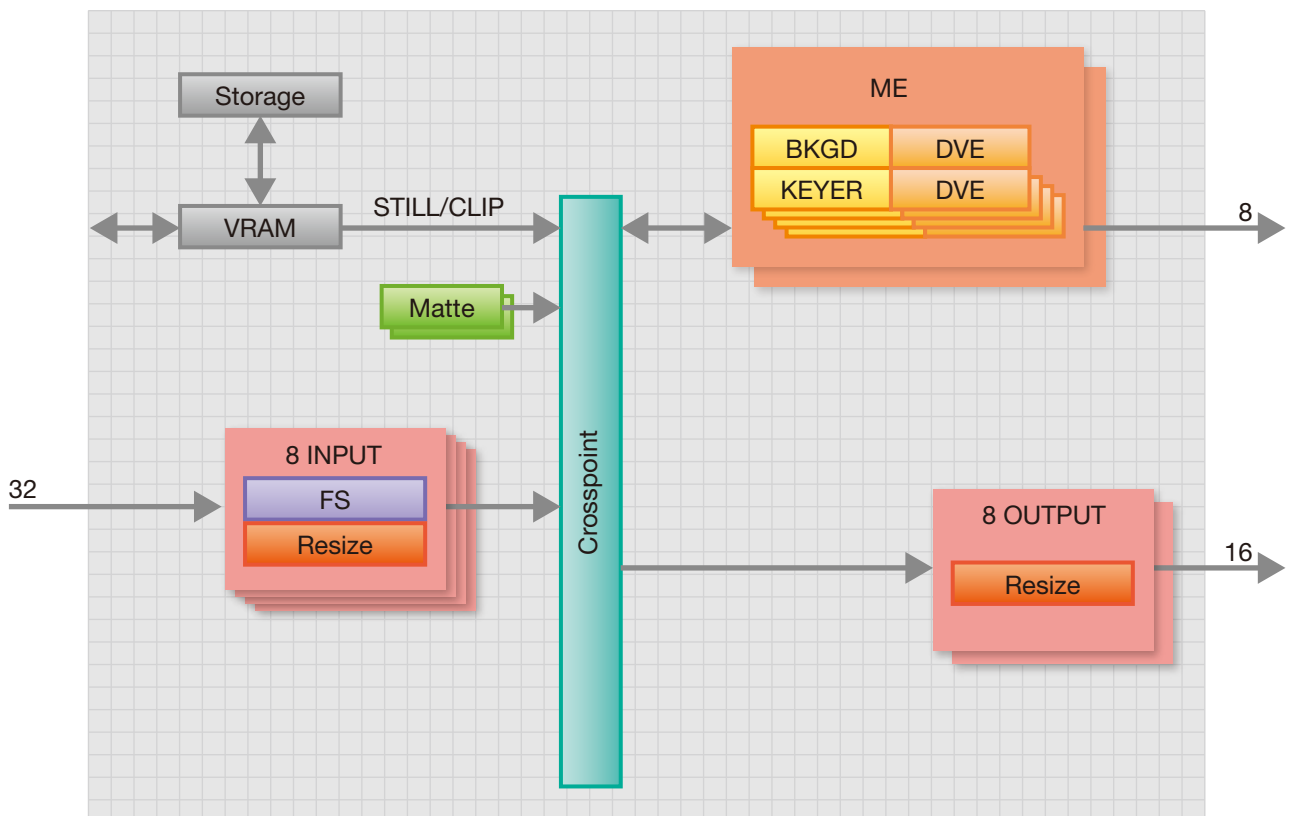

## Options

### Expansion Cards

5 input slots, 2 I/O slots, 1 M/E slot and 1 M/E or option<sup>\*1</sup> slot.

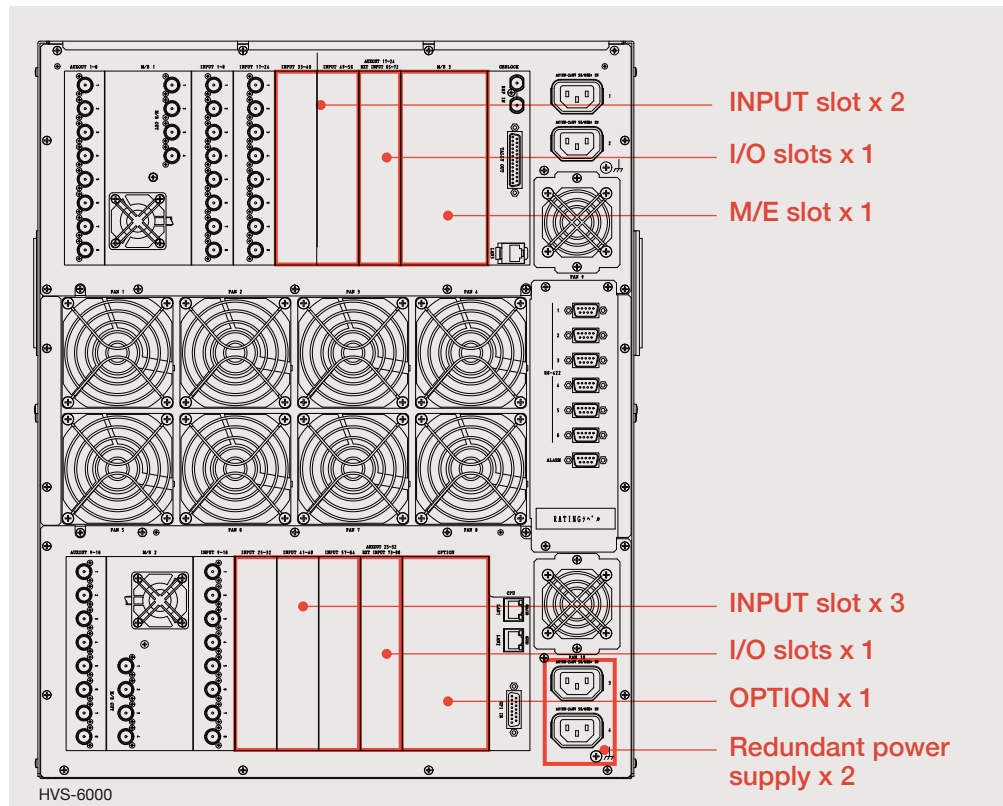

#### [Available options]

##### INPUT slot

- HVS-6000SDI

##### I/O slot

- HVS-6000SDO
- HVS-6000SDI-EX
- HVS-6000IP-8IO

##### M/E slot

- HVS-6000ME (M/E expansion)

##### OPTION slot

- HVS-6000ME (DSK expansion)
- HVS-6000MV

##### Redundant power supply

- HVS-6000PSM

#### [For HVS-6000]

- HVS-6000ME: M/E / DSK expansion card  
M/E expansion if installed on M/E slot and DSK expansion if installed on OPTION slot. Expandable to 4M/E with the HVS-6000ME4 and 2 HVS-6000ME units.
- HVS-6000SDI-EX: 12G-SDI Input expansion card (for I/O slots)  
8 input channels per card. Up to 2 cards can be installed on I/O slots.
- HVS-6000SDO: 12G-SDI Output expansion card  
8 output channels per card. 2 cards standard, expandable to 4.

#### [For HVS-6000 or HVS-6000M]

- HVS-6000SDI: 12G-SDI Input expansion card  
8 input channels per card. 3 cards standard, expandable to 8 (HVS-6000) or 4 (HVS-6000M).

### Software

#### [For HVS-6000]

- HVS-6000ME4: Software license for 4M/E expansion  
4M/E expansion with 2 HVS-6000ME options with this license.  
(2 HVS-6000ME are required.)

#### [For HVS-6000 or HVS-6000M]

- HVS-6000SDIC: Up-converter software license for each input  
Adds upconversion capability from HD to 4K for input.
- HVS-6000SDOC: Down-converter<sup>\*3</sup> software license for each AUX output  
Adds downconversion capability from 4K to HD for AUX output.

\*1 For details, contact your FOR-A dealer. \*2 To be supported. \*3 UHD 4K to HD only.



## Options

### Other Options

#### [For HVS-6000 or HVS-6000M]

- HVS-AUX16A/32A/64A/16B/16C/16D: Auxiliary Unit (Ethernet LAN connection)  
Up to 12 units\* can be connected.



HVS-AUX16A  
(16-buttons)



HVS-AUX16B  
(16-buttons, table-top model)



HVS-AUX16C  
(16-buttons with OLED displays)



HVS-AUX16D  
(16-buttons with OLED display,  
table-top model)



HVS-AUX32A  
(32-buttons)



HVS-AUX64A  
(64-buttons)

- HVS-GPIO128: Interface Extension Unit (Ethernet LAN connection)  
1RU-sized GPI control unit. 128 GPI I/O can be freely assigned.
- HVS-6000PSM: Power supply units for power redundancy
- HVS-TALR32: Tally Control Unit (Relay type) (RS-422 connection)
- HVS-TALOC32: Tally Control Unit (Open Collector type) (RS-422 connection)

\* To be supported.

## HVS-6000/6000M Datasheet

### 1. Specifications

#### Basic specifications

Temperature	0°C to 40°C	
Humidity	30% to 90% (no condensation)	
Power	100 V - 240 V AC $\pm$ 10%, 50/60 Hz	
Consumption	[HVS-6000]	Standard: 1070 W (at 100-120 V) 1016 W (at 220-240 V) Full option: 2213 W (at 100-120 V) 1972 W (at 220-240 V)
	[HVS-6000M]	Standard: 873 W (at 100-120 V) 856 W (at 220-240 V) Full option: 930 W (at 100-120 V) 895 W (at 220-240 V)
Dimensions	[HVS-6000]	430 (W) x 500 (D) x 532 (H) mm 480 (W) (including rack mount brackets)
	[HVS-6000M]	430 (W) x 500 (D) x 310 (H) mm 480 (W) (including rack mount brackets)
Weight	[HVS-6000]	65 kg (With all options: 80 kg)
	[HVS-6000M]	45 kg (With all options: 47 kg)
Consumables (at 24-hour operation)	Power supply unit: Replace every 5 years. Cooling fans: Replace every 5 years. SSD: Replace every 5 years (which vary depending on usage environment).	

#### Technical specifications

Number of M/Es	[HVS-6000]	Standard :	2M/E
		HVS-6000ME x 1:	3M/E
		HVS-6000ME x 2:	3M/E+DSK
		HVS-6000ME x 2 + HVS-6000ME4:	4M/E
	[HVS-6000M]		2M/E
Video format	UHD 4K: 2160p /59.94, 50 (Single Link 12G-SDI) 2160p/ 29.97, 25, 24, 23.98 (6G-SDI Single Link) Full HD: 1080p / 59.94, 50 (Level-A only) HD: 1080i / 59.94, 50 10-bit YCbCr 4:2:2		
Video input	12G-SDI: 12 Gbps, 6G-SDI: 6Gbps, 3G-SDI: 3 Gbps, HD-SDI: 1.5 Gbps 75 $\Omega$ BNC		
Video input (option)	HVS-6000SDI / HVS-6000SDI-EX 12G-SDI: 12 Gbps, 6G-SDI: 6Gbps, 3G-SDI: 3 Gbps, HD-SDI: 1.5 Gbps 75 $\Omega$ BNC x 8		
Number of inputs	[HVS-6000]	Standard: 24, Max: 80	
	[HVS-6000M]	Standard: 24, Max: 32	
Video output	12G-SDI: 12 Gbps, 6G-SDI: 6Gbps, 3G-SDI: 3 Gbps, HD-SDI: 1.5 Gbps 75 $\Omega$ BNC		
Video output (option)	HVS-6000SDO 12G-SDI: 12 Gbps, 6G-SDI: 6Gbps, 3G-SDI: 3 Gbps, HD-SDI: 1.5 Gbps 75 $\Omega$ BNC x 8		
Number of outputs	[HVS-6000]	Standard: 24 (AUX 16), Max: 48 (included 32 auxiliaries)	
	[HVS-6000M]	24 (AUX 16)	
Color sampling	10-bit YCbCr Key: 4:2:2:4		
Reference input	75 $\Omega$ BNC x 1 w/ loop-through (Terminate with 75 $\Omega$ if not used.)		

System phase adjust	(Horizontal) -1/2H to +1/2H	
I/O delay	Minimum delay:	UHD 4K/FullHD: 2H HD: 1H (depending on conditions)
	W/ FS:	0-1 frame
	W/ up-converter:	Interlaced signal input: 0.5 to 1.5 frames Progressive signal input: 0-1 frame
	W/ DVE:	Interlaced: 1 frame Progressive: 2 frames
	W/ SUB EFFECT:	Interlaced: 1 frame Progressive: 2 frames
Effects	Wipe patterns:	100 (W/ modifier)
	DVE patterns:	2D pattern: 19, 3D pattern: 68 (W/ modifier)
	2D DVE: Std: 8 channels (1 channel per KEY, including DVE patterns) Max: 16 channels (in 4 M/E) 3D DVE: Std: 2 channels (1 channel per M/E BKGD, including DVE patterns) Max: 4 channels (in 4 M/E)	
	Sub effects	Mono color, Defocus, Paint, Mosaic, etc. Available for M/E PGM, PST, KEY1-4
Transition	Execution: Fader, AUTO or CUT button Type: MIX or WIPE (DVE and CG WIPE included)	
Still/Clip store	[HVS-6000] UHD 4K: 4 channels (W/ key), FullHD/HD: 8 channels (W/ key) [HVS-6000M] UHD 4K: 2 channels (W/ key), FullHD/HD: 4 channels (W/ key) Built-in RAM UHD 4K: 2,000 non-compressed frames (Approx. 30 sec) FullHD/HD: 8,000 non-compressed frames (Approx. 120 sec) Auto backup/resume	
KEY	[HVS-6000] Std: 8 channels (4 per M/E), Max. 16 channels [HVS-6000M] Std: 8 channels (4 per M/E) Bus key, Luminance key, Full key and Chroma key, Mask and Invert	
DSK (HVS-6000 only)	4 channels (4 keys and 4 backgrounds) Bus key, Luminance key and Full key, Mask	
Multiview output (HVS-6000MV) (HVS-6000 only)	MV Out: 4, BNC (MV images also assignable to AUX outputs) MV 4 channels: 4 independent layouts with 2 sets of window sources for MV1/2 and MV3/4 (Max 16 windows, input/images and clocks assignable) Information display: Audio level meter, Title, Safety area marker, On-air tally, Frame border I/O delay: Interlace: 1 frame Progressive: 2 frames	
Event memory buffers	Global: 100, Local: 100, Keyer: 8, Control panel: 10	
Macros	100 macros	
Interfaces		
LAN 1 (MAIN) LAN 2 (SUB)	100BASE-TX/1000BASE-T, RJ-45 x 2 For OU Control Unit and other device connection	
GPI IN	15-pin D-sub (female) x 1 (w/ inch screws) 12 inputs	
TALLY OUT	25-pin D-sub (female) x 1 (w/ inch screws) 23 outputs	
RS-422	9-pin D-sub (female) x 6 (w/ inch screws) For Tally Unit connection	
ALARM	9-pin D-sub (female) x 1 (w/ inch screws) Fan and power alarms, Relay contact output	

### HVS-6000 options

HVS-6000ME	M/E / DSK expansion card (M/E expansion if installed on M/E slot and DSK expansion if installed on OPTION slot)
HVS-6000PSM	Power Supply Units (UNIT 3/4) for power redundancy
HVS-6000SDI	12G-SDI Input expansion card
HVS-6000SDI-EX	12G-SDI Input expansion card (for I/O slots)
HVS-6000SDO	12G-SDI Output expansion card
HVS-6000SDIC	Up-converter software license for each input
HVS-6000SDOC	Down-converter software license for each output
HVS-6000MV	Multiview output expansion card
HVS-6000ME4	4M/E expansion with 2 HVS-6000ME options with this license

### HVS-6000M options

HVS-6000PSM	Power Supply Units for power redundancy
HVS-6000SDI	12G-SDI Input expansion card
HVS-6000SDIC	Up-converter software license for each input
HVS-6000SDOC	Down-converter software license for each output

### HVS Series options

HVS-AUX16A/32A/64A/16B/16C/16D	Auxiliary Unit (Ethernet LAN connection)
HVS-TALR32	Tally Control Unit (Relay type) (RS-422 connection)
HVS-TALOC32	Tally Control Unit (Open Collector type) (RS-422 connection)
HVS-GPIO128	Interface Extension Unit (Ethernet LAN connection)
HVS-2000TPU	Touch Panel Unit
HVS-2000TPUS	Touch Panel Unit with PC

### Accessories

AC Cord, Rack Mount Brackets, HVS-6000 CD-ROM, and Quick Setup Guide

**2. External Dimensions**

(All dimensions in mm.)

**HVS-6000**

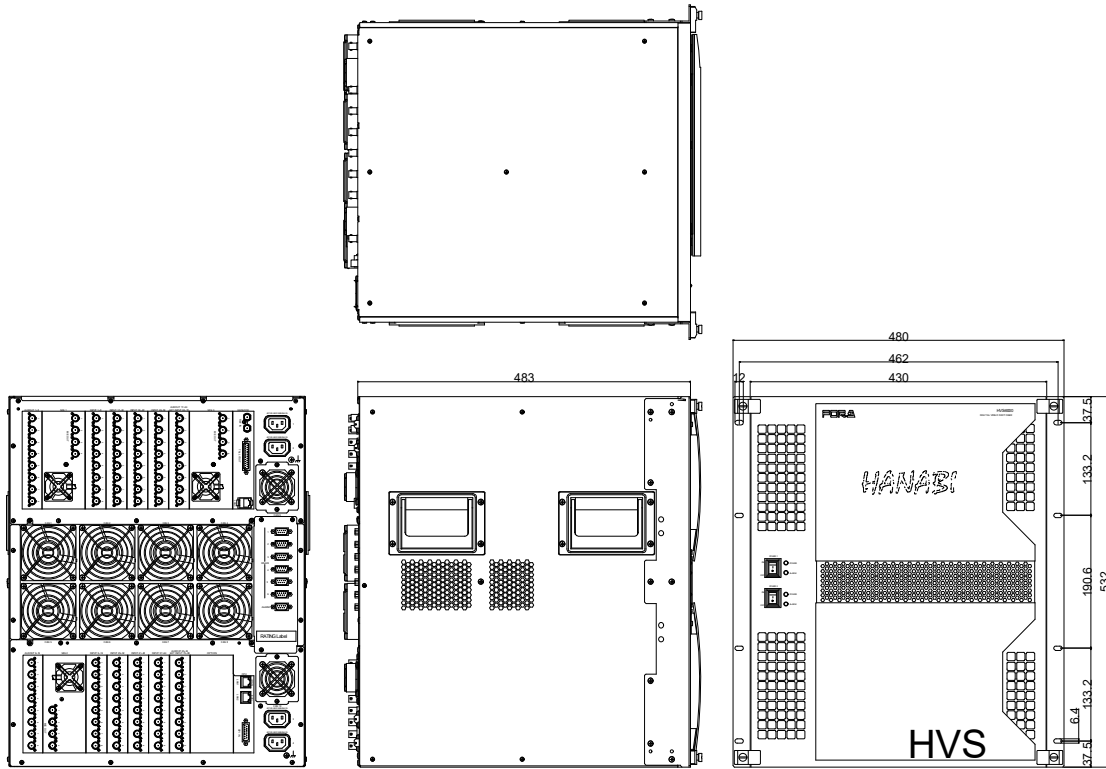

**HVS-6000M**

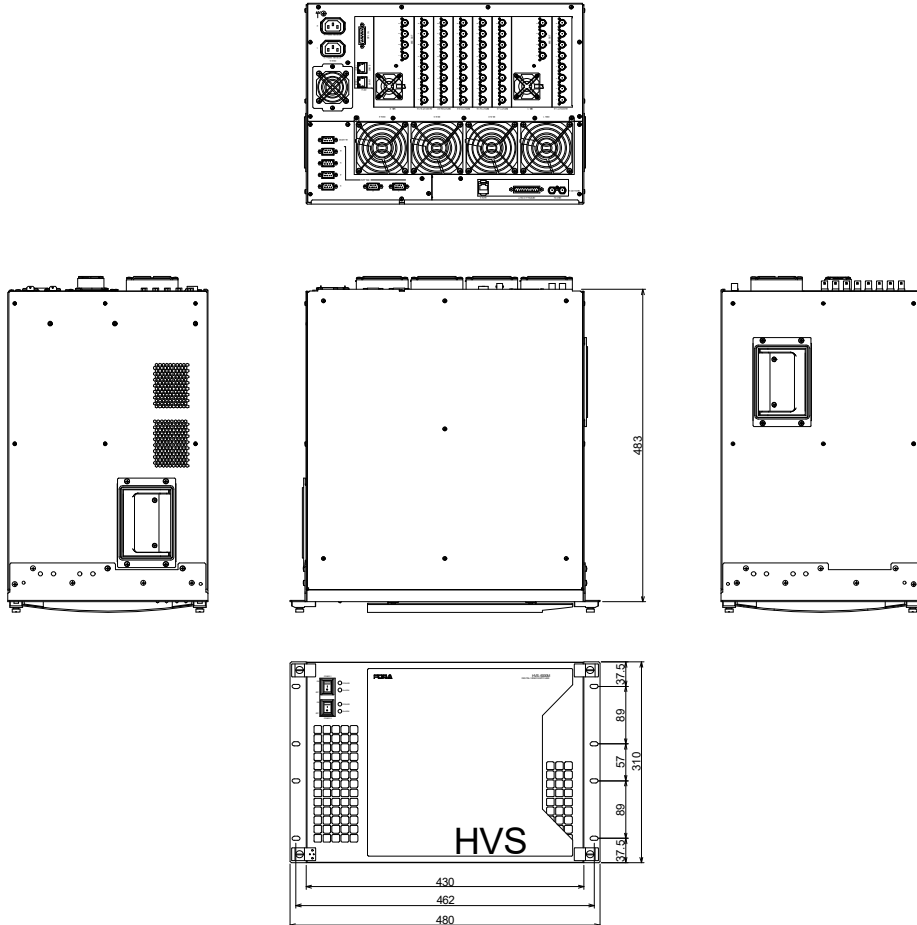

## HVS-3355OU/OUA Datasheet

### 1. Specifications

#### Basic specifications

Temperature	0°C to 40°C
Humidity	30% to 90% (no condensation)
Consumption	150 W (if in normal configuration, 35 buttons and 3 M/Es)
Power	[OU Control Unit] AC 100 V - 240 V ±10%, 50/60 Hz [Touch Panel Unit] DC 12 V or DC 48 V [LINE Unit] DC 12 V or DC 48 V [AUX Bus Unit] DC 12 V or DC 48 V
Dimensions	1300 (W) x 528(D) x 68 (H) mm (LINE Unit x 3, AUX Unit x 1, plane placement)
	[OU Control Unit] 430 (W) x 300 (D) x 88 (H) mm 480 (W) (including rack mount brackets) [Touch Panel Unit] 374 (W) x 58 (D) x 221 (H) mm [LINE Unit] 1300 (W) x 132 (D) x 68 (H) mm [AUX Bus Unit] 777 (W) x 132 (D) x 68 (H) mm
Weight	[OU Control Unit] 5 kg (With redundant power supply: 6 kg) [Touch Panel Unit] 3 kg [LINE Unit] 8 kg [AUX Bus Unit] 5 kg
Consumables(*1) (at 24-hour operation)	[OU Control Unit] Power supply unit: Replace every 5 years. [Touch Panel Unit] SBC battery: Replace every 2 years after factory shipment.

(\*1) Replace the battery every 1 year when the unit powered off for an extended period.

#### OU Control Unit: Technical specifications

Supported switcher	HVS-2000 HVS-6000/6000M
LAN port	RJ-45 x 7 For OU component connection and external device connection
TO TOUCH PANEL UNIT	9-pin D-sub (female) x 1 (w/ inch screws)
GPI IN/TALLY OUT	25-pin D-sub (female) x 1 (w/ inch screws) 12 inputs /12 outputs
DC OUTPUT (OUT1)	Cannon 3-pin XLR (female) x 1 (DC 48 V distributed output)

#### Touch Panel Unit: Technical specifications

Display	TFT LCD, 12.1-inch, w/ multi-touch RJ-45 x 7 For OU Control Unit and other device connection
SBC	Windows 7 Embedded, Windows IoT
TO CONTROL UNIT	RS-422 9-pin D-sub (female) x 1 (for OU Control Unit connection)
EXT PC block	
HDMI IN	Type-A connector x 1

SW CONTROL	USB Type-B connector x 1
PANEL SENSOR	USB Type-B connector x 1
USB1, USB2	USB Type-B connector x 2
LAN 2 (SUB)	RJ-45 x 2 (for OU control panel connection)
USB port	USB Type-A connector x 4
HDMI OUT	Type-A connector x 1
DC 12 V IN	AC adapter input
DC 48 V IN	Cannon 3-pin XLR x 1 (Power supplied from OU Control Unit)

#### LINE Unit: Technical specifications

Bus button	35 (switched by SEL) x 2 rows (for key video, macro and user) 35 (4 levels) x 2 rows (for M/E background video source)
Control Unit	RJ-45 x 1
Ethernet	RJ-45 x 1 (for OU control panel connection)
DC 12 V IN	AC adapter input
DC 48 V IN DC 48 V OUT	Cannon 3-pin XLR x 1 (Supplied from OU Control Unit in cascade connection) Cannon 3-pin XLR x 1 (Supplied from OU Control Unit in cascade connection)

#### AUX Bus Unit: Technical specifications

Bus Button	35 (switched by SEL) x 2 rows (for AUX bus, DSK bus, MACRO and USER) 35 (4 levels) x 2 rows (for video source)
Control Unit	RJ-45 x 1
Ethernet	RJ-45 x 1 (for OU Control Unit connection)
DC 12 V IN	AC adapter input
DC 48 V IN DC 48 V OUT	Cannon 3-pin XLR x 1 (Supplied from OU Control Unit in cascade connection) Cannon 3-pin XLR x 1 (Supplied from OU control Unit in cascade connection)

#### Option

HVS-3355PSO	Power Supply Unit for OU (Control Unit)'s power redundancy
-------------	--

#### Accessories

LAN cable, RS-422 cable, AC power cable, DC canon cable, Rack Mount Brackets

**2. External Dimensions**

(All dimensions in mm.)

**HVS-3355OU/OUA**

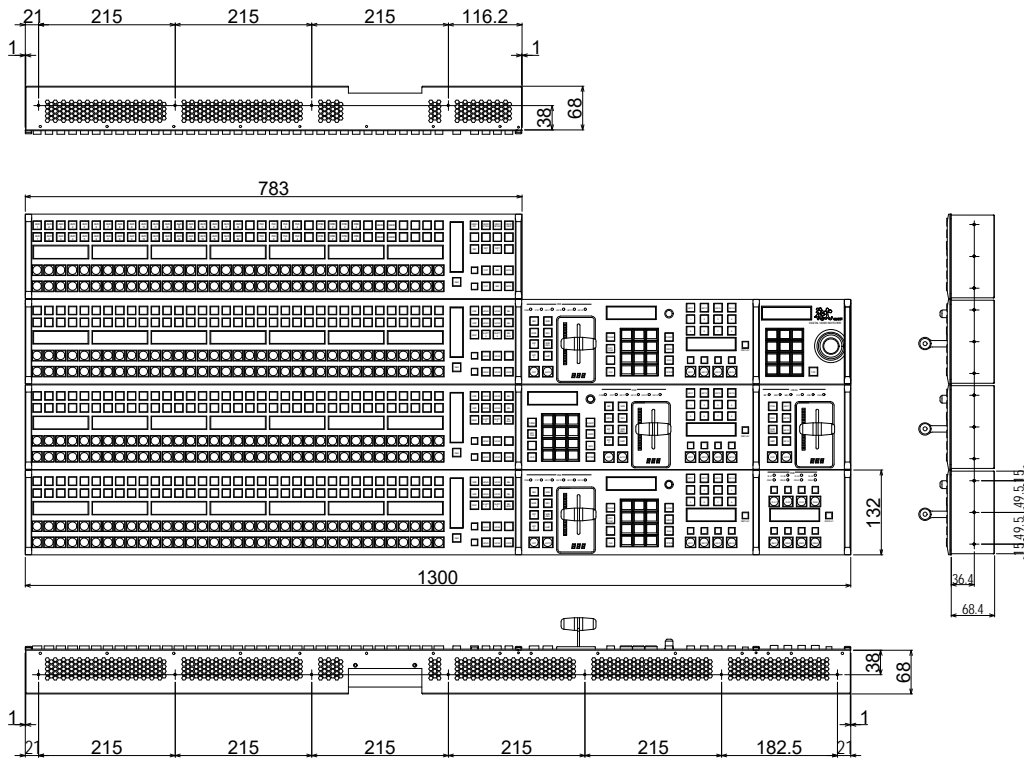

**AUX bus unit**

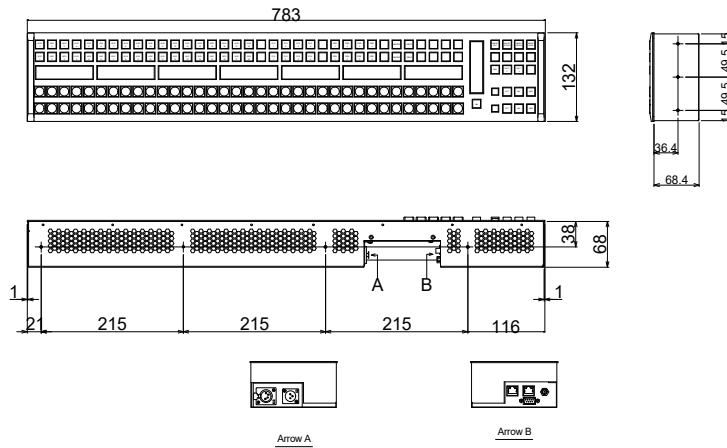

**LINE unit**

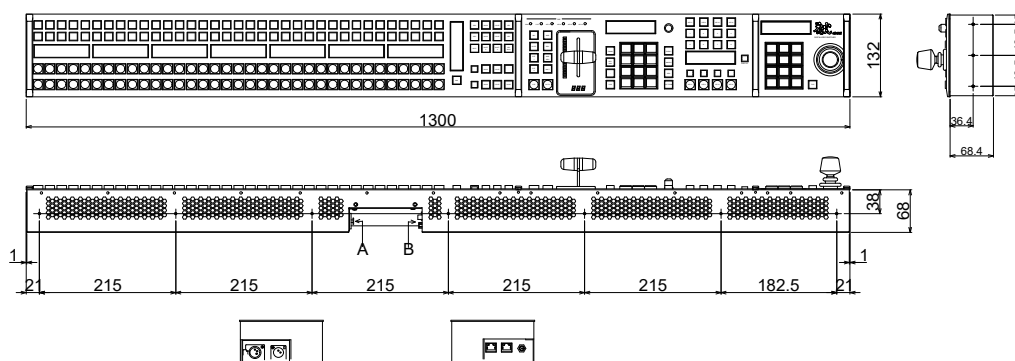



(All dimensions in mm.)

**Control unit**

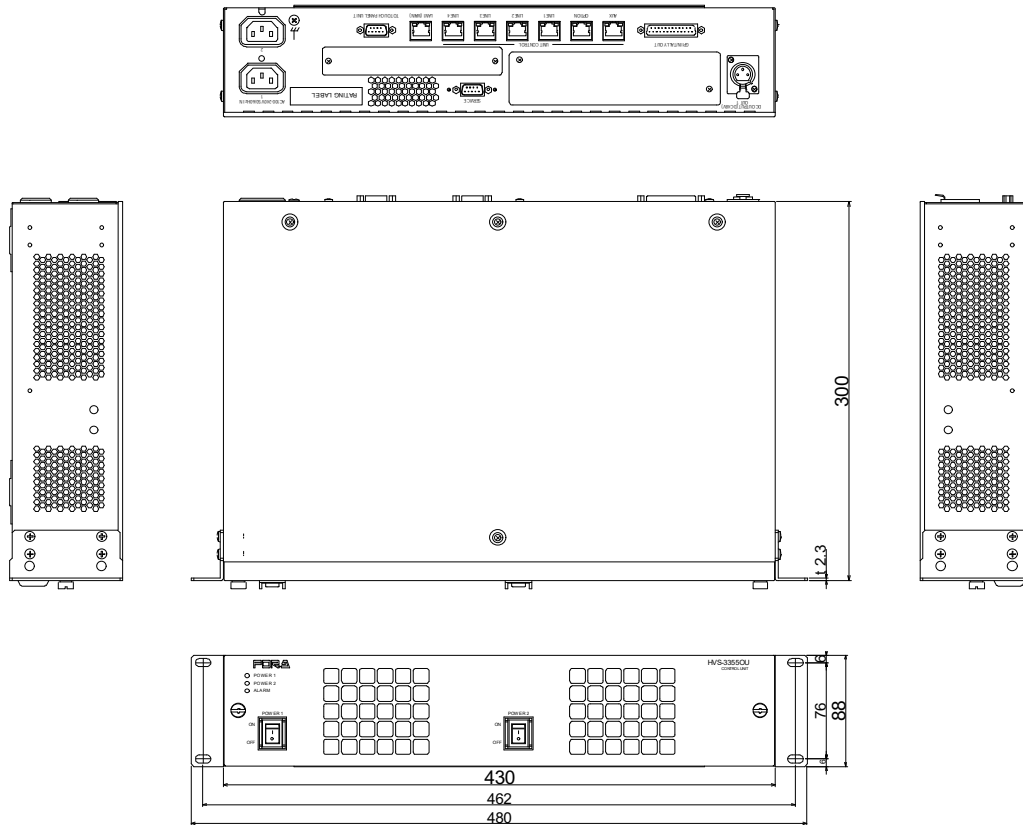

**Touch panel unit**

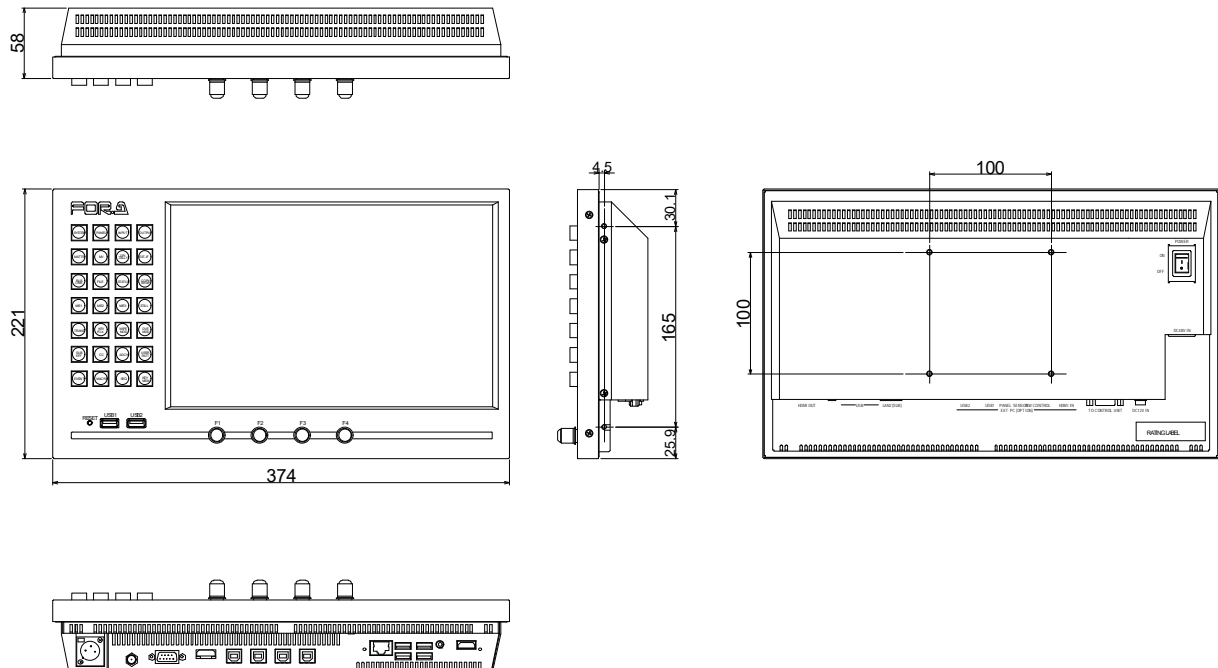

## HVS-2240OU/2240OUA, 3320OU, 2120ROU Datasheet

### 1. Specifications

#### Basic specifications

Temperature	0°C to 40°C		
Humidity	30% to 90% (no condensation)		
Power	AC100V - 240V ±10% 50/60Hz		
Consumption	[2240OU]	46 W (at 100-120 V)	46 W (at 220-240 V)
	[2240OUA]	57 W (at 100-120 V)	47 W (at 220-240 V)
	[3320OU]	67 W (at 100-120 V)	63 W (at 220-240 V)
	[2120ROU]	46 W (at 100-120 V)	46 W (at 220-240 V)
Dimensions	[2240OU/OUA]	1060 (W) x 354 (D) x 155 (H) mm	
	[3320OU]	1196 (W) x 494 (D) x 155 (H) mm	
	[2120ROU]	430 (W) x 420 (D) x 127 (H) mm	
Weight	[2240OU]	12 kg	
	[2240OUA]	15.5 kg	
	[3320OU]	22 kg (23 kg w/ redundant power supply)	
	[2120ROU]	8 kg	
Consumables(*1) (at 24-hour operation)	Power supply unit:	Replace every 5 years.	
	SBC battery:	Replace every 2 years after factory shipment. (2240OU/3320OU/2120ROU)	
		Replace every 3 years after factory shipment. (2240OUA)	

(\*1) Replace the battery every 1 year when the unit powered off for an extended period.

#### Technical specifications

Supported switcher	HVS-2000 HVS-6000/6000M		
Number of lines	[2240OU/OUA]	2	
	[3320OU]	3	
	[2120ROU]	2	
Number of bus buttons	[2240OU/OUA]	24	
	[3320OU]	32	
	[2120ROU]	12	
Interfaces			
VGA	For PC monitor connection		
HDMI	For touch panel connection		
USB	[2240OU/2240OUA, 3320OU]	Panel: 2.0 (Type-A) x 2	Rear: 2.0 (Type-A) x 4
	[2120ROU]	Panel: 2.0 (Type-A) x 2	Rear: 3.0 (Type-A) x 2
LAN 1 (MAIN)	RJ-45 x 1	For HVS-2000 connection	
LAN 2 (SUB)	[2240OU/OUA, 3320OU]	RJ-45 x 1	For HVS-2000 connection
	[2120ROU]	RJ-45 x 2	For HVS-2000 connection
GPI IN/TALLY OUT	[2240OU/OUA, 3320OU]	25-pin D-sub (female) x 1 (inch screws) 12-input/12-output	

GPI I/O	[2120ROU]	5-pin D-sub (female) x 1 (inch screws) 6-input/6-output
DC OUTPUT(5V)	[2120ROU]	4-pin XLR x 1 For LED lam (w/ power switch and controller)
LAMP	[2120ROU]	USB 2.0 (Type-A) x 1 For LED lighting

**HVS-2240OU / 3320OU Options**

HVS-2000PSO	Redundant power supply unit for HVS-2240/3320OU
-------------	---

**HVS-2240OU/2240OUA, 3320OU, 2120ROU Accessories**

Bus button partition plate (2240OU/2240OUA, 3320OU), User button cover plate (3320OU), Control cables, AC Cord or AC adapter

**2. External Dimensions**

(All dimensions in mm.)

**HVS-2240OU**

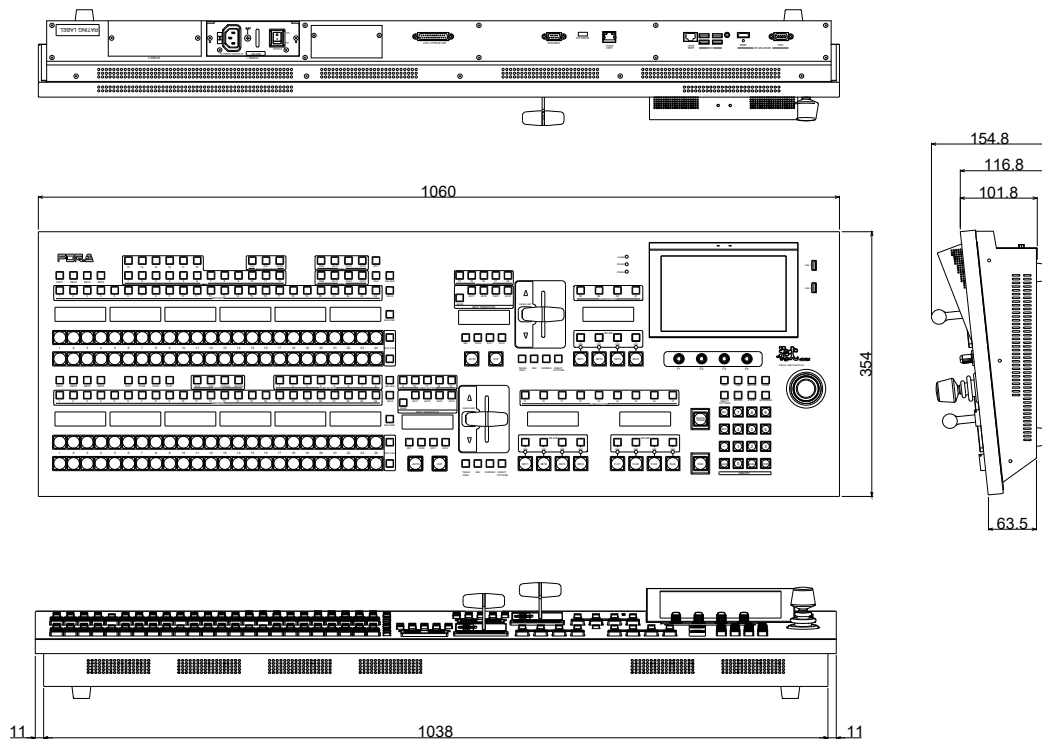

**HAV-2240UA**

(All dimensions in mm.)

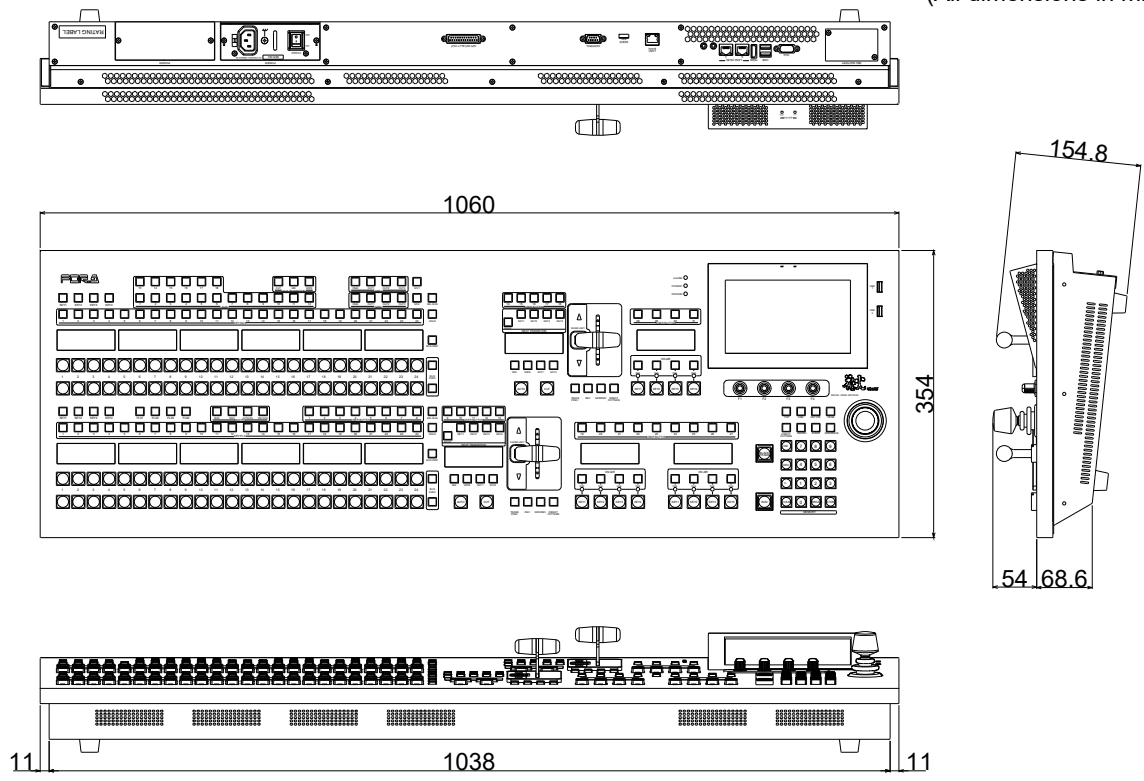

**HVS-3320OU**

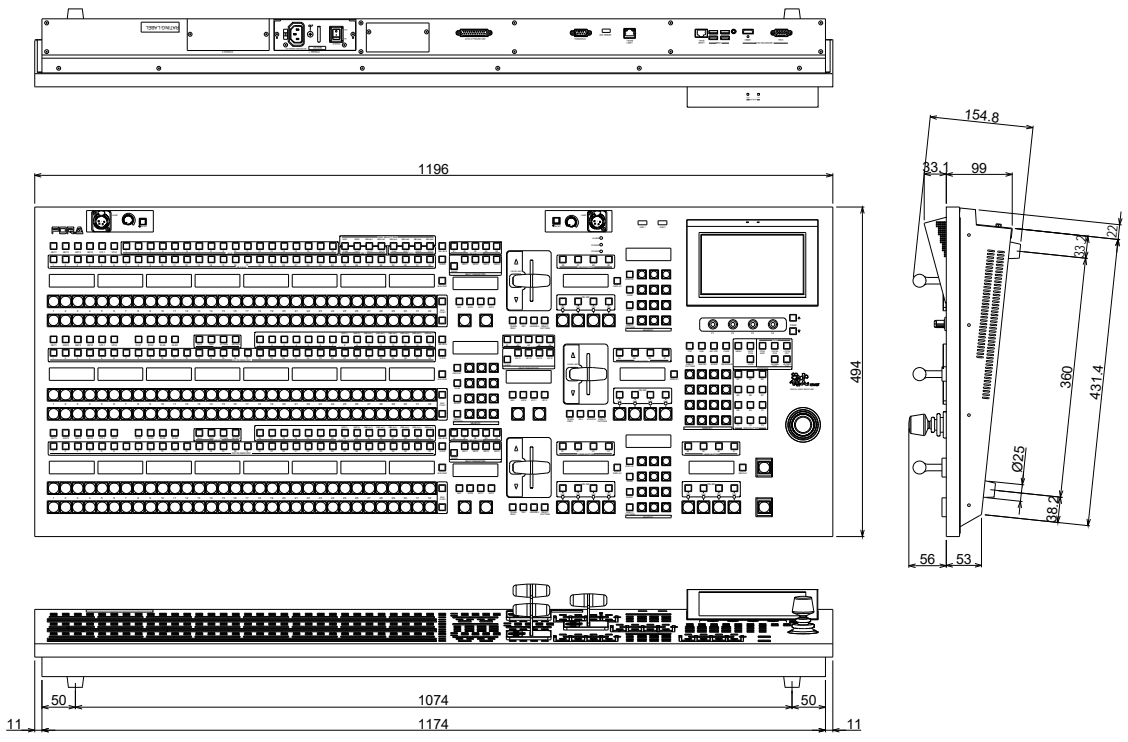

(All dimensions in mm.)

HVS-2120ROU

